

KATALOG PRODUKTÓW

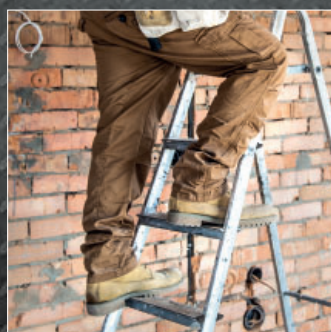
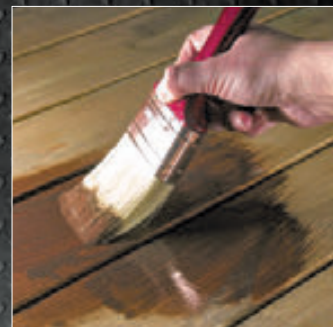
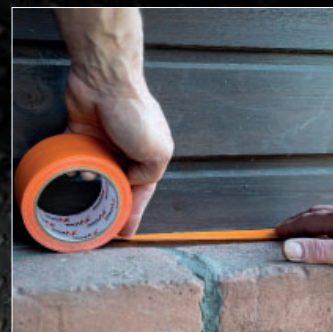

**CENTRALA:**

ul. Mazowiecka 10, 96-300 Żyrardów

tel.: +48 46 854 42 47, fax: 46 855 00 76

e-mail: biuro@inter-s.pl, www.inter-s.pl, www.motive.tools**EXPORT:**e-mail: export@inter-s.pl

1	Zachodniopomorskie	508 092 867 668 569 367 734 210 165	szczecin@inter-s.pl
2	Wielkopolskie	668 568 881 501 044 589 734 210 163 538 551 049	poznan@inter-s.pl
3	Lubuskie	787 148 646	gorzow@inter-s.pl
4	Kujawsko-Pomorskie	668 569 459 880 894 947	bydgoszcz@inter-s.pl
5	Pomorskie	508 092 862 668 570 323	gdansk@inter-s.pl
6	Warmińsko-Mazurskie	508 092 864 509 311 627	olsztyn@inter-s.pl
7	Podlaskie	501 044 594 882 919 878 668 568 676	bialystok@inter-s.pl
8	Lubelskie	668 568 676 509 838 429 532 086 568 882 919 878	lublin@inter-s.pl
9	Mazowieckie	508 092 803 508 092 804 510 291 055 668 568 676	warszawa@inter-s.pl
10	Podkarpackie	668 568 650 795 534 525	rzeszow@inter-s.pl
11	Świętokrzyskie	668 571 917 509 838 429	biuro@inter-s.pl
12	Małopolskie	664 126 467	krakow@inter-s.pl
13	Śląskie	882 351 549 886 322 213	biuro@inter-s.pl
14	Łódzkie	668 572 145 668 571 917 795 506 598 734 210 163	lodz@inter-s.pl
15	Dolnośląskie Opolskie	539 772 134 880 520 178	wroclaw@inter-s.pl

7-18	FOLIE I ARTYKUŁY OCHRONNE ПЛЕНКИ, СРЕДСТВА ЗАЩИТЫ FOILS AND PROTECTIVE ARTICLES SCHUTZARTIKEL UND FOLIEN FOLII PROTECTIE, ECHIPAMENT PROTECTIE	
19-40	ODZIEŻ ROBOCZA I ARTYKUŁY BHP СПЕЦОДЕЖДА И СТАТЬИ ПО БЕЗОПАСНОСТИ WORKWEAR AND SAFETY ARTICLES ARBEITSKLEIDUNG UND SICHERHEITSARTIKEL ARTICOLE DE ÎMBRĂCĂMINTE DE LUCRU ȘI DE SIGURANȚĂ	
41-56	TASMY ЛЕНТЫ TAPES BÄNDER BENZI ADEZIVE	
57-96	ARTYKUŁY MALARSKIE МАЛЯРНЫЕ ИНСТРУМЕНТЫ PAINTING TOOLS AND ACCESSORIES MALERWERKZEUGE UNELTE DE ZUGRAVIT	
97-130	NARZĘDZIA BUDOWLANE СТРОИТЕЛЬНЫЕ ИНСТРУМЕНТЫ CONSTRUCTION TOOLS BAUWERKZEUGE UNELTE CONSTRUCTII	
131-144	PĘDZLE I SZCZOTKI КИСТИ PAINTBRUSHES PINSEL, BESEN PENSULE, BIDINELE, MATURI	
145-156	ARTYKUŁY ŚCIERNE АБРАЗИВЫ ABRASIVE ARTICLES SCHLEIFZUBEHÖR ABRAZIVE	
157-176	ARTYKUŁY GLAZURNICZE I NARZĘDZIA DO TAPETOWANIA ИНСТРУМЕНТ ДЛЯ ОБЛИЦОВОЧНЫХ РАБОТ И НАКЛЕЕВАНИЯ ОБОЕВ TILING ACCESSORIES AND WALLPAPERING TOOLS FLIESEN- UND TAPETIERZUBEHÖR SCULE MONTAJ PLACI CERAMICE	
177-184	TARCZE I WIERTŁA ДИСКИ И СВЕРЛ DISCS, DRILLS TRENNSCHEIBEN UND BOHRER DISCURI, BURGHIE	
185-206	ARTYKUŁY RÓŻNE РАЗНОЕ OTHER PRODUCTS SONTIGES ACCESORII	
207-212	NARZĘDZIA I AKCESORIA STOLARSKIE СТОЛЯРНЫЙ ИНСТРУМЕНТ И АКЦЕССУАРЫ CARPENTRY TOOLS AND ACCESSORIES TISCHLERWERKZEUG UNELTE PENTRU PRELUCRAT LEMN	
213-236	DRABINY ЛЕСТНИЦЫ LADDERS LEITERN SCĂRI	
237-257	ARTYKUŁY OGRODNICZE ИНСТРУМЕНТЫ ДЛЯ САДА И ОГОРОДА GARDENING EQUIPMENT GARTENWERKZEUGE UNELTE PENTRU GRADINA	

ALFABETYCZNY SPIS TREŚCI

A					
Adapter do kija teleskopowego Wooster	92	Kielnia do gazobetonu	111	Mata malarska	11
Adapter do szpachli alu do gipsu	113	Kielnia fugowa	108	Mata malarska Sticky	12
Adapter do szpachli fasadowych soft	115	Kielnia fugowa	110	Mata remontowa Cover-Tex	12
Amortyzator do szelek	23	Kielnia kątowa	108	Miara ABS	195
Automatyczny wieszak na 9 narzędzi	249	Kielnia kątowa	110	Miara Auto-lock	196
B		Kielnia murarska	111	Miara drewniana	197
Big bag	17	Kielnia sztukatorska	109	Miara Soft	196
Bity	191	Kielnia trapezowa	109, 111	Miara stalowa	195-196
Bity z ogranicznikiem	191	Kielnia trójkątna	109, 111	Miara zwijana	196
Bluza polarowa	35	Kieszenie wiszące	36	Mieszadło do farb	89
Brzeszczot	187	Kij aluminiowy KLIK	251	Mieszadło	119-120
Buty ochronne	38-39	Kij do grabi	251	Minirap komplet	14
C		Kij do mioty i smołowca	142	Minirap zapas	14
Chłapak	139	Kij do smołowca	140	Minirusztowanie z podestem	219
Cyklina	152	Kij do szczotki	142	Miotła ulicówka	140
Czerpak murarski	120	Kij do ulicówki	140	Miotła ulicówka ze skrobakiem	140
D		Kije teleskopowe	91-92	Miotły	141-142
Drabina - platforma dla tynkarzy	218	Kliny i klipsy do poziomowania płytek	159	Miseczka do gipsu	120-121
Drabina alu 2-elementowa Motive	231	Kliny montażowe	160	Młotek ciesielski	127-128
Drabina alu 3-elementowa Basic	233	Klucz do skręcania drutu	126	Młotek gumowy	129-130
Drabina alu 3-elementowa Motive	232	Kłódka mosiężna	202	Młotek murarski	129
Drabina alu dwustronna Domo	224	Kłódka trzpieniowa wzmocniona	203	Młotek stolarski	128-129
Drabina alu dwustronna Motive	223	Kłódka żelwna	202	Młotek ślusarski	128
Drabina alu jednostronna Domo	222	Kombinezon malarski	23	Mop do czyszczenia gładzi Wooster	150
Drabina alu jednostronna Motive	221	Komplet glazurniczy	161	Mop do czyszczenia gładzi Wooster - zapas	150
Drabina alu przystawna Basic	229	Komplet malarski	76	Motyczko-grabki	248
Drabina alu przystawna Motive	228	Końcówka zraszająca	245	Myjka do wałków	88, 95
Drabina przegubowa	236	Końcówki wyciskacza do mas	200	N	
Drabina teleskopowa	215	Koszula flanelowa	35	Nakolanniki	28-29
Drabina wielofunkcyjna	216	Koszyk na owoce	250	Nakolanniki Waterloo	36
Drabina wielofunkcyjna z podestem	234	Koziołek drewniany	220	Naświetlacz LED	204-205
Drabina wolnostojąca	214	Kółka do wiadra glazurniczego	161	Nauszniki ochronne	20
Dysk szlifierski	148	Kółko wymienne ze śrubą	166	Niezbędnik ogrodowy	239
Dyspenser	55	Kratka malarska	91	Nożyce do cięcia blachy	126-127
Dyspenser z folią Speedy Mask	13	Krążki Superpad	149	Nożyce do trawy	252
E		Krążki ścierne	148	Nożyczki monterskie	172
Euromal	88	Krążki Yellow Pad	149	Nożyczki uniwersalne	172
F		Kreda budowlana	194	Nożyk do folii	171
Folia budowlana atest	15	Kreda traserska	194	Nóż 2blades	168
Folia malarska	11	Krzyżyki dystansowe	162	Nóż automatyczny	168
Folia ochronna	11	Krzyżyki dystansowe z uchwytem	161	Nóż do kartonu	169
Folia samoprzylepna niebieska	13	Kurtki	35	Nóż do szkła	171
Folia samoprzylepna przezroczysta	13	Kurtka przeciwdeszczowa	22	Nóż do wełny	172
Folia Speedy Mask	13	Kurtyna przeciwpyłowa	14	Nóż do wykładzin	170
Frez do styropianu	183	Kuweta do szpachlowania	119	Nóż hakowy	169
Fugownica	162	Kuwety malarskie	60, 89, 90	Nóż Interlock	170
G		Kuweta metalowa Wooster	90	Nóż łamany	170
Gąbka do fug epoksydowych	163	Kuweta narzędziowa	190	Nóż łamany ABS	170
Gąbka do glazury	163	L		Nóż łamany kółko	170
Gąbka do szlifowania	151	Listwa do klinkieru	165	Nóż łamany Profi	169
Gąbka do szlifowania diament	146, 151	Listwa zaciskowa przedłużająca	211	Nóż łamany wzmocniony	171
Gąbka hydro	163	Listwy zaciskowe prowadzące	210, 211	Nóż metalowy trapezowy	171
Gąbka z gumą	163	Ł		Nóż Pocket	168
Gogle gospodarcze	20	Łapka do gwoździ	127	Nóż Push-Lock	169
Grabie	251	Łata murarska	125	Nóż Securo	168, 176
Grabie do liści	250-252	Łata murarska + uchwyt	126	Nóż z ostrzem łamanym	169
Grabki	248	Ławkowiec	139	O	
K		Łącznik do węża	242-243	Okulary ochronne	21
Kamizelka odbłaskowa	22	Łącznik redukcyjny	242-243	Ołówki	192-193
Kamizelka zimowa	36	Łącznik szybkołączek	242	Opaski zaciskowe	206
Kask ochronny	20	Łopata	254	Ostrza „hakowe”	173
Kastra budowlana	121	Łopata do śniegu	203	Ostrza do fazownika (strugu)	152
Kątownik metalowy	126	Łopata węglowa	255	Ostrza do noża do wykładzin	174
Kątownik stolarski	212	Łopatka uniwersalna	248	Ostrza do skrobaka	93
Kątownik stolarski aluminiowy	212	M		Ostrza łamane	172-173
Kątownik stolarski do zaciskania	208	Markery	193-194	Ostrza trapezowe	173
		Maski przeciwpyłowe	22	Ostrze do tarnika	152
		Maszynka do glazury	165-166	Otwornica	183
		Mata budowlana Protaktor	12	Otwornica do glazury	166

P					
Paca do fugowania z gumą ściętą	164	Przyłbica ochronna	22	Sznurek polipropylenowy	197
Paca do spoinowania	164	Przyrząd do układania glazury	167	Sznurek PP UV	198
Paca poliuretanowa	104	R		Szpachelka	116
Paca styropianowa	103-104	Rajberka ABS	103	Szpachelka - skrobak	118
Paca tarka	107	Rajberka aluminiowa	100	Szpachelka z bitem	116
Paca z filcem	105	Rajberka HI-FLEX	99-100	Szpachelka do tapetowania	168
Paca z gąbką	104-105	Rajberka nierdzewna	100-102	Szpachelka malarska	118
Paca z gumą	105-106	Rajberka plastikowa	103	Szpachelka nierdzewna	118
Paca z włókniną	164	Rajberka wenecka	100	Szpachelka nierdzewna fasadowa	117
Papier Speedy Mask	13	Redukcja przyłącza	242	Szpachelka wielofunkcyjna 6w1	117
Papier ścierny do trójkąta Wooster	150	Rękawice ochronne	23-28	Szpachelki do silikonu	174
Papier ścierny w rolce	147	Rękawice z pazurkami	249	Szpachelki japońskie	118-119
Pasek	36	Rolka do gładzi	95	Szpachla alu do gipsu	113
Pasy transportowe	202	Rolka do narożników	82	Szpachla alu do gipsu - adapter	113
Pazurki-kultywator	248	Rolka do odcinania kolorów	83	Szpachla alu do gipsu - ostrza	113
Pędzel angielski	135	Rolka do odcinania kolorów - zapas	83	Szpachla fasadowa soft	116
Pędzel do akryli	134	Rolka do pasków	83	Szpachla fasadowa soft - adapter	116
Pędzel do dekoracji	138	Rolka do pasków - osłona	83	Szpachla HI-FLEX	115
Pędzel do pasków	137	Rolka do pasków - zapas	83	Szpachla HI-FLEX - kij teleskopowy	115
Pędzel kaloryferowy	138	Rolka do rur	84	Szpachla nierdzewna	117
Pędzel kaloryferowy V-PRO	137	Rolka do rur - zapas	84	Szpachla RE-FLEX	114
Pędzel Motive Red	134	Rolka do siatki	75	Szpachla zębata	117
Pędzel okrągły	136	Rolka do struktur	84	Szpachle z walizką HI-FLEX - zestaw	115
Pędzel Wood	134	Rolka do tapet	167	Szpadel	254
Pędzel owalno-płaski	137	Rolka do wiadra glazurniczego	161	Szpilka do agrowłókniny	250
Pędzel płaski do emulsji	136	Rolka do wylewek	175	Szufelka C.O.	254
Pędzel płaski nylon do akryli	136	Rolka Dulux	71	Szufelka metalowa	143
Pędzel półangielski	136	Rolka Elitakolor	69	Szufelka ze zmiotką	143
Pędzel V-PRO	133	Rolka Girpaint	68	Szybkozłączka	240
Pędzel V-PRO do pasków	137	Rolka Mikrofaza	72	Ścierka do podłogi	14
Pędzel V-PRO okrągły	137	Rolka Multopren	75	Ścierka tetra	14
Pędzel Winger	134	Rolka Multikolor	69	Ściernica listkowa	149
Pikownik	249	Rolka Nylon	74	Ściernica listkowa diament	146, 149
Piła 4 in 1	187	Rolka Orange	71	Ściski pełnowierzchniowe	209
Piła do gazobetonu	188	Rolka Rollex Thick	72	Ściski stolarskie pistoletowe	212
Piła do metalu	187	Rolka Syntex	70	Ściski stolarskie sprężynowe	212
Piła do płyt gips-karton	188	Rolka Welur	76	Ściski stolarskie śrubowe	212
Piła płatnica	188	Rolka Westan	71	T	
Piła uniwersalna składana	252	Rozdzielacz z zaworami	244	Tablica budowlana informacyjna	204
Pistolet do pianki montażowej	200	Rysik do glazury	166	Tapetówka	138
Pistolet do unoszenia płytek	159	S		Tapetówka Motive	138
Pistolet do zraszania	245-246	Sekator	252-253	Tarcza diamentowa Turbo/Super Turbo	180
Pistolet klejowy	205-206	Siatka do ociepleń	55	Tarcza diamentowa uniwersalna	180
Pistolet mini do pianki montażowej	200	Siatka ścierna	150	Tarcza do cięcia metalu	181
Plandeka z oczkami	16	Siekiera	256	Tarcza do cięcia stali	181
Plandeki malarskie	9-10	Siewnik ręczny	250	Tarcza Meshy Blade	178, 180
Plótno ściernie Klingspor	147	Skrobak	93-94	Tarnik typ blok	152
Podest roboczy	225	Skrobak do fug	165	Taśma akustyczna	50
Podest roboczy H, platforma	216	Skrobak do silikonu	174	Taśma aluminiowa	52
Podpora teleskopowa	192	Skrzynka na drobnice	190	Taśma antypoślizgowa	52
Pojemnik elastyczny	121	Skrzynka na drobnice z uchwytem	191	Taśma antyrysowa	48
Pojemnik okrągły	121	Skrzynka narzędziowa	189-190	Taśma Blue Masking Tape	43
Pokrowiec na poziomnicę	124	Skrzynka uciosowa	188-189	Taśma delikatna	43
Pokrywa	93	Skuwacz do lodu	203	Taśma do klejenia folii	46
Pokrywka do wiadra białego	121	Smołowiec szary	139	Taśma do klejenia kartonu	54
Poziomica Drywall	123	Spodnie robocze	31, 32, 33, 35	Taśma do membran dachowych	46
Poziomica Electric	124	Spychacz ręczny do śniegu	204	Taśma do otulin	51
Poziomica HV	123	Strug (fazownik) do płyt	151	Taśma dwustronna	45
Poziomica Motive Red	123	System poziomowania wielokrotnego użytku	159	Taśma Fix Extreme	50
Poziomica Optical 6 oczek	122	Szablon do kształtów	167	Taśma izolacyjna	51
Poziomica Plumber	124	Szczotka do kosiarzki ze skrobakiem	255	Taśma lakiernicza	46
Poziomica Profi magnes	124	Szczotka doczołowa	152-153	Taśma łączeniowa	47
Poziomica Sharky	123	Szczotka druciana	154-155	Taśma maskująca precyzyjna	44
Poziomica wodna	126	Szczotka druciana do kostki	141	Taśma maskująca	43
Próbnik elektryczny	204	Szczotka tarczowa	154	Taśma maskująca blue	44
Przecinak ze stali stopowej	127	Szczypce do systemu poziomowania płytek	160	Taśma metalizowana	51
Przedłużacz	205	Szelki bezpieczeństwa	23	Taśma miernicza	197
Przyłącze	240-241	Sznur murarski	197	Taśma montażowa	50
		Sznur traserski	195	Taśma opakowaniowa	53-54

Taśma opakowaniowa z własnym nadrukiem	55	Walek wooster Mikrofibra	78
Taśma ostrzegawcza	53	Walek wooster Mohair blend	77
Taśma papierowa	49	Walek wooster pro/doo-z	77
Taśma PE Promask	45	Walek wooster Super fab	77
Taśma Power Fix	50	Wąż ogrodowy „Bos”	239
Taśma PVC	44-45	Wąż ogrodowy Carbon	239
Taśma reperacyjna	48	Wąż ogrodowy rozciągliwy	239
Taśma Sime łączeniowa	49	Wiadro	92, 93, 122
Taśma Sime narożnikowa	49	Wiadro budowlane	121
Taśma ślizgowa	48	Wiadro glazurnicze	161
Taśma tynkarska	47	Widelki	248
Taśma tynkarska do boni	47	Widły	253
Taśma uniwersalna	46	Wiertła HSS Gold Black - zestaw	179, 181
Taśma uszczelniająca PTFE	51	Wiertło HSS do metalu	182
Taśma UV PE	45	Wiertło HSS Titan zestaw	182
Taśma White Masking Tape	43	Wiertło sds do betonu	183
Taśma wodoodporna	44	Wieszak ścienny na wąż	239
Taśma z wkładką	49	Wkład Arctic	63
Taśma z włókna szklanego	48	Wkład do kuwety	89-90
Tektura budowlana izolacyjna	12	Wkład do kuwety 16/28	90
Tektura falista	12	Wkład Girpaint	67
Temperówka do ołówków stolarskich	193	Wkład Microgreen	63
Trójkąt do szlifowania gładzi - Wooster	150	Wkład Microstar	64
Trójnik	243-244	Wkład Midi nylon	73
Trzony do siekiery i toporka	256	Wkład Mikrofaza	72
Trzon do kilofa	130	Wkład Moltopren	74
Trzon do łopaty	255	Wkład Multikolor	68
Trzon do młotka	130	Wkład Nylon	65
Trzon do szpadla	255	Wkład Silveramid	62
T-shirt	36	Wkład Springfield	61
U		Wkład Syntex	69-70
Uchwyt do wałków regulowany	59, 79	Wkład Velur	66
Uchwyt do wałków Wooster	81-82	Wkład Velur	75
Uchwyt koszykowy	79	Wkład Volcano	61
Uchwyt magnetyczny do bitów	192	Wkład Wooster	76
Uchwyt malarski	78	Wkłady klejowe	206
Uchwyt malarski Soft	80	Włóknina biała	164
Uchwyt naświetlacz LED	204	Włóknina czarna	165
Uchwyty magnetyczne do glazury	167	Worki	19-20
Uszczelki	201-202	Wycieraczka szczotkowa	143-144
W		Wyciskacz	198-199
Walizka do szpachli	114	Wyciskacz plastikowy	200
Walek Arctic	63	Wykrojnik	167
Walek Bluecolor	62	Z	
Walek do gładzi	72	Zacieraczka	148
Walek Girpaint	68	Zamiatacz Profi	141
Walek Goldline	65	Zamiatacze	141
Walek Greenfield	63	Zapas do Euromalu	89
Walek Microgreen	64	Zapas filc	105
Walek Microstar	64	Zapas gumowy do pacy fugowej	164
Walek Mikrofaza	72	Zapas Moltoflok	73
Walek Multikolor	68	Zatyczki do uszu	20
Walek Nylon	65-66	Zdzierak do tynków	107-108
Walek Nylon	74	Zestaw 3 narzędzi ogrodowych	249
Walek Orange	71	Zestaw do poziomowania płytek	160
Walek Poliazur	66	Zestaw szpachli alu z walizką	113
Walek Poligreen	63	Zestawy malarskie	84-88
Walek Silveramid	62	Zgarniacz wody	174
Walek Springfield	61	Złączki do węży - zestaw sklepowy (box)	257
Walek Syntex	70	Zmiotka	143-144
Walek Velur	66	Zraszacz	246-247
Walek Velur	75	Zszywacz tapicerski	201
Walek Volcano	61	Zszywki	201
Walek V-PRO Fibra	67	Zszywki Stanley	201
Walek V-PRO Nylon	67	Zwijacz na wąż ogrodowy	240
Walek V-PRO PES	67	Żyłka gospodarcza	198
Walek wooster Lambswool	77		
Walek wooster Micro Plush	78		
Walek wooster Microfibre	77		

FOLIE I ARTYKUŁY OCHRONNE

ПЛЕНКИ, СРЕДСТВА ЗАЩИТЫ • FOILS AND PROTECTIVE ARTICLES
• SCHUTZARTIKEL UND FOLIEN • FOLII PROTECTIE, ECHIPAMENT PROTECTIE



FOLIA SPEEDY MASK

FOLIA MALARSKA + TAŚMA MASKUJĄCA W JEDNYM

FOLIA SPEEDY MASK to szybki i skuteczny sposób na zabezpieczanie ścian, okien, listew przypodłogowych oraz mebli podczas prac malarsko-remontowych. Cienka folia w sześciu rozmiarach i dwóch długościach nawoju fabrycznie uzbrojona jest w taśmę maskującą, co pozwala na sprawne przygotowanie i ochronę powierzchni przed zabrudzeniem lub uszkodzeniem podczas wielu prac.

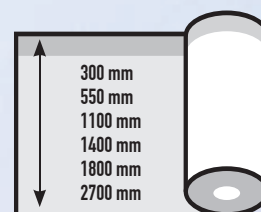
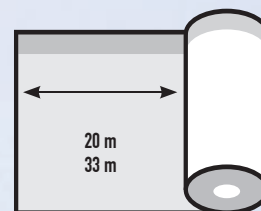

NAKLEJASZ, ROZKŁADASZ I MASZ ZABEZPIECZONE!



Idealnie odcięte krawędzie

Nośnik z klejem, niepozostawiającym śladów przy ściąganiu taśmy

Precyzyjna taśma maskująca o dwóch szerokościach: 17 mm i 25 mm

Cienka folia przylegająca do powierzchni na zasadzie elektrostatyki

Łatwy sposób rozkładania folii

FOLIA SPEEDY MASK

NUMER KATALOGOWY						
010 234	17 mm	9 µm	300 mm	33 m	1/50	
010 235	17 mm	9 µm	550 mm	33 m	1/50	
010 232	25 mm	9 µm	1100 mm	33 m	1/25	
010 236	25 mm	9 µm	1400 mm	20 m	1/25	
010 237	25 mm	9 µm	1800 mm	20 m	1/25	
010 233	25 mm	9 µm	2700 mm	20 m	1/25	

POLECAMY RÓWNIEŻ DYSPENSER DO JESZCZE ŁATWIEJSZEJ APLIKACJI FOLII SPEEDY MASK.

ŁATWY SPOSÓB NA ROZWIJANIE I OBCIĘCIE FOLII.

Nr kat. 010 282 do folii w rozmiarach od 1100 do 2700 mm

Nr kat. 010 281 do folii w rozmiarach 300 mm i 550 mm





PLANDEKA MALARSKA GAT. I

Plastic drop sheet, I quality • Плёнка малярная сорт 1 • Abdeckfolie
 • Folie protectie

NUMER KATALOGOWY				
010 206	60 µm	4 m	5 m	10/480



PLANDEKA MALARSKA GAT. I

Plastic drop sheet, I quality • Плёнка малярная сорт 1 • Abdeckfolie
 • Folie protectie

NUMER KATALOGOWY				
010 515	42 µm	4 m	5 m	20



PLANDEKA MALARSKA GAT. I

Plastic drop sheet, I quality • Плёнка малярная сорт 1 • Abdeckfolie
 • Folie protectie

NUMER KATALOGOWY				
010 205	30 µm	4 m	5 m	15/720



FOLIA MALARSKA OPAL

Plastic drop sheet LDPE • Плёнка малярная • Malerplane
 • Folie protectie

NUMER KATALOGOWY				
010 513	60 µm	4 m	5 m	10



FOLIA MALARSKA OPAL

Plastic drop sheet LDPE • Плёнка малярная • Malerplane
 • Folie protectie

NUMER KATALOGOWY				
010 512	45 µm	4 m	5 m	15





motive
Jakość ma znaczenie

LDPE



FOLIA MALARSKA OPAL

Plastic drop sheet LDPE • Плёнка малярная • Malerplane
• Folie protectie

NUMER
KATALOGOWY



30 µm



4 m



5 m



15



LDPE



PLANDEKA MALARSKA 4/5 CZERWONA

Plastic drop sheet red LDPE • Плёнка малярная красная • Malerplane
• Folie protectie

NUMER
KATALOGOWY



60 µm



4 m



5 m



10/480



LDPE



PLANDEKA MALARSKA 4/5 NIEBIESKA

Plastic drop sheet blue LDPE • Плёнка малярная голубая • Malerplane
• Folie protectie

NUMER
KATALOGOWY



40 µm



4 m



5 m



20/800



LDPE



PLANDEKA MALARSKA 4/5 ŻÓŁTA

Plastic drop sheet yellow LDPE • Плёнка малярная жёлтая • Malerplane
• Folie protectie

NUMER
KATALOGOWY



30 µm



4 m



5 m



20/960



LDPE



PLANDEKA MALARSKA 4/5 ZIELONA

Plastic drop sheet green LDPE • Плёнка малярная зеленая • Malerplane
• Folie protectie

NUMER
KATALOGOWY



20 µm



4 m



5 m



25/1200



FOLIA MALARSKA

Plastic drop sheet HDPE • Плёнка малярная • Abdeckfolie • Folie protectie

NUMER KATALOGOWY				
010 208	7 µm	4 m	5 m	50/2400
010 243	7 µm	4 m	12,5 m	1/25

motive
 Jakość ma znaczenie



FOLIA MALARSKA

Plastic drop sheet HDPE • Плёнка малярная • Abdeckfolie • Folie protectie

NUMER KATALOGOWY				
010 210	5 µm	4 m	5 m	40



FOLIA OCHRONNA

Polythene dust sheet roll • Пленка защитная • Abdeckfolie • Folie protectie

NUMER KATALOGOWY				
010 209	35 µm	3 m	20 m	1



MATA MALARSKA

Dust sheet fleece • Защитная пленка с фетром • Malerabdeckvlies • Păslă de acoperire

NUMER KATALOGOWY				
010 115	180 g/m ²	1 m	10 m	1/6/120

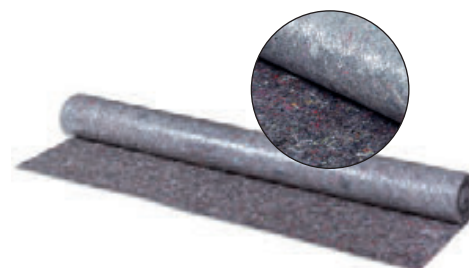

MATA MALARSKA

Dust sheet fleece • Защитная пленка с фетром • Malerabdeckvlies • Păslă de acoperire

NUMER KATALOGOWY				
010 116	220 g/m ²	1 m	10 m	1/6

motive
 Jakość ma znaczenie

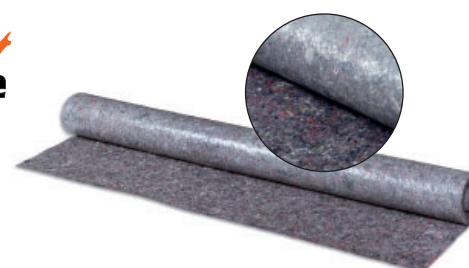

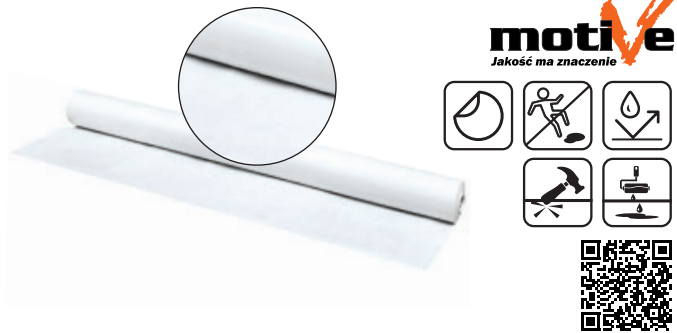

motive
Jakość ma znaczenie



MATA MALARSKA STICKY

Dust sheet fleece sticky • Защитная пленка с фетром sticky
• Abdeckvlies selbstklebend • Pâslă de acoperire

NUMER KATALOGOWY			
010 117	100 cm	10 m	1/6
010 118	50 cm	10 m	1/6



motive
Jakość ma znaczenie

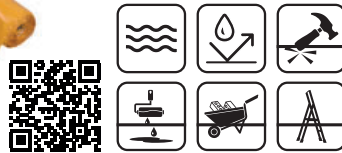

MATA BUDOWLANA PROTEKTOR

Heavy duty protection pad • Пленка строительная с войлоком Protektor
• Bodenschutzmatte • Pâslă de acoperire Protektor

NUMER KATALOGOWY			
010 264	1 m	10 m	1



motive
Jakość ma znaczenie



MATA REMONTOWA COVER-TEX

Non-woven Cover-Tex • Пленка ремонтная с нетканым материалом
• Bodenschutzmatte • Pâslă de acoperire Cover-Tex

NUMER KATALOGOWY			
010 265	1 m	10 m	1



TEKTURA FALISTA

Corrugated cardboard roll • Картон волнистый • Rollenwellpappe
• Carton ondulat de protectie

NUMER KATALOGOWY			
010 113	1 m	15 m	1/40



TEKTURA BUDOWLANA IZOLACYJNA

Building paper roll • Картон строительный изоляционный • Abdeckpappe
• Carton de protecție

NUMER KATALOGOWY			
010 114	1 m	15 m	1/80



FOLIA SPEEDY MASK

Pre taped masking film • Плёнка защитная SPEEDY MASK с липким слоем
 • Abdeckfolie mit Selbstklebeband • Banda de mascare cu folie de protectie

NUMER KATALOGOWY					
010 232	25 mm	9 µm	1100 mm	33 m	1/25
010 233	25 mm	9 µm	2700 mm	20 m	1/25
010 234	17 mm	9 µm	300 mm	33 m	1/50
010 235	17 mm	9 µm	550 mm	33 m	1/50
010 236	25 mm	9 µm	1400 mm	20 m	1/25
010 237	25 mm	9 µm	1800 mm	20 m	1/25

PAPIER SPEEDY MASK

Pre-taped masking paper • Защитная бумага speedy mask • Abdeckpapier mit Klebeband • Hartie mascare cu banda adeziva

NUMER KATALOGOWY				
010 275	25 mm	300 mm	20 m	1/6
010 276	25 mm	450 mm	20 m	1/6

DYSPENSER Z FOLIĄ SPEEDY MASK

Pre taped masking film with dispenser • Пленка защитная с клейкой лентой • Abdeckfolie mit Klebeband plus Abroller • Banda de mascare cu folie de protectie + dispenser

NUMER KATALOGOWY					
010 281	17 mm	9 mm	550 mm	20 m	1/6
010 282	25 mm	9 mm	2700 mm	20 m	1/6

FOLIA SAMOPRZYLEPNA NIEBIESKA

Window protection film blue • Самоклеящаяся защитная пленка
 • Selbstklebende Schutzfolie - blau • Folie de protectie autoadezivă

NUMER KATALOGOWY				
010 214	50 µm	25 cm	30 m	1/12/360
010 216	50 µm	50 cm	30 m	1/6/180
010 217	50 µm	50 cm	75 m	1/6/168
010 285	40 µm	50 cm	75 m	1/6

FOLIA SAMOPRZYLEPNA PRZEZROCZYSTA

Window protection film transparent • Пленка самоклеящаяся бесцветная
 • Selbstklebende Schutzfolie - transparent • Folie de protectie autoadezivă

NUMER KATALOGOWY				
010 262	50 µm	50 cm	30 m	1/6/180
010 263	50 µm	50 cm	75 m	1/6/180

motive
 Jakość ma znaczenie

HDPE



motive
 Jakość ma znaczenie



motive
 Jakość ma znaczenie

HDPE



motive
 Jakość ma znaczenie



motive
 Jakość ma znaczenie

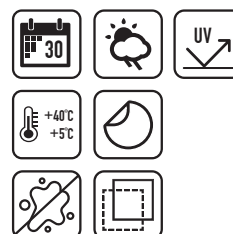



motive
Jakość ma znaczenie



KURTYNA PRZECIWPYŁOWA

Dust stop zip door • Пылезащитная шторка • Folien Staubschutztür mit Reißverschluss • Folie uşă anti-praf

NUMER KATALOGOWY			
010 238	120 cm	220 cm	1/6



ŚCIERKA DO PODŁOGI 5 szt.

Floor cleaning cloth (5 pcs) • Тряпка половая (5шт.) • Bodentuch (5 Stück)
• Cârpă pentru şters podeaua (5 buc)

NUMER KATALOGOWY	Color			
010 380	biała/white	60 cm	70 cm	5/20
010 381	szara/grey	60 cm	70 cm	5/20



ŚCIERKA TETRA 20 szt.

Cotton cleaning cloth (20 pcs) • Тряпка тетровая (20 шт.)
• Mullwaschlappen (20 Stück) • Cârpă tetra (20 buc)

NUMER KATALOGOWY			
010 382	80 cm	60 cm	1/30



MINIRAP KOMPLET

Stretch wrap mini roll dispenser • Мини-рап комплект • Mini-Stretchfolie mit Dispenser • Folie stretch manuala tip mini roll

NUMER KATALOGOWY		
010 231	10 cm	1/27



MINIRAP ZAPAS 2 szt.

Mini stretch wrap, 2 pcs. • Мини-рап, ролики (2 шт.) • Mini-Stretch folie 2 Stücke • Folie stretch manuala tip mini roll

NUMER KATALOGOWY		
010 230	10 cm	1/20

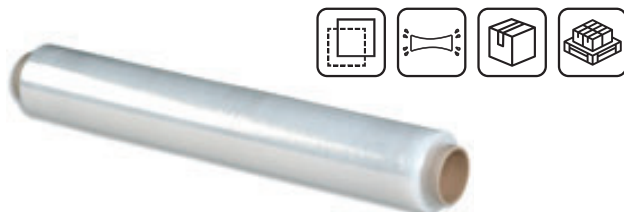

FOLIA STRETCH 23 µm

Stretch wrap film, clear • Плёнка STRETCH • Handstreichfolie- transparent
• Folie extensibila

NUMER KATALOGOWY			
010 220	50 cm	1,2 kg netto	6/300
010 218	50 cm	2,5 kg netto	6



FOLIA STRETCH CZARNA 23 µm

Stretch wrap film, black • Плёнка STRETCH чёрная • Handstreichfolie- schwarz
 • Folie extensibila neagra

NUMER KATALOGOWY			
010 219	50 cm	1,2 kg netto	6/300
010 212	50 cm	2,5 kg netto	6



FOLIA CZARNA PE

Black foil PE • Плёнка защитная чёрная • LDPE-Folie, schwarz
 • Folie PE neagra

NUMER KATALOGOWY			
010 108	4 m	5 m	1/5



FOLIA BUDOWLANA ATEST

Black foil PE • Плёнка защитная чёрная (сертификация)
 • Baufolie mit Zertifikat • Folie PE neagra

NUMER KATALOGOWY				
010 103	0,2 mm	5 m	20 m	1



FOLIA CZARNA PE

Black foil PE • Плёнка защитная чёрная PE • Baufolie • Folie PE neagra

NUMER KATALOGOWY			
010 109 TYP 150	5 m	20 m	1/50
010 110 TYP 150	4 m	25 m	1/50
010 111 TYP 200	4 m	25 m	1/50
010 112 TYP 200	5 m	20 m	1/50
010 106 TYP 300	5 m	20 m	1/90



FOLIA PAROIZOLACYJNA - ATEST

Yellow foil PE • Плёнка пароизоляционная (сертификация)
 • Dampfsperrfolie mit Zertifikat • Folie PE galben





NUMER KATALOGOWY				
010 104	0,2 mm	2 m	50 m	1





WORKI DO ODPADÓW LEKKICH 1200x2400 5 szt.





Rubbish bags • Мешки для легкого мусора • Müllsäcke • Saci Polietilena

NUMER KATALOGOWY				
010 245	120x240 cm	500 L	5	1/15



WORKI NA GRUZ 10 szt.

Rubble bags (10 pcs) • Мешки для строительного мусора (10 шт.)
• Schwergutsäcke (10 Stück) • Saci pentru moloz (10 bucati)

NUMER KATALOGOWY				
010 258	60x100cm	70 L	10	1/4
010 242	70x110 cm	120 L	10	1/4

motive
Jakość ma znaczenie





010 242
010 258



WORKI PRZEMYSŁOWE CZARNE 10 szt.

Rubble sacks (10 pcs) • Промышленные мешки (10 шт.)
• Schwergutsäcke (10 Stück) • Saci pentru moloz (10 bucati)

NUMER KATALOGOWY			
010 150	60x100 cm	70 L	1/30
010 151	70x110cm	120 L	1/30
010 152	80x135 cm	160 L	1/30
010 153	120x140 cm	240 L	1/20
010 154	125x160 cm	320 L	1/15

motive
Jakość ma znaczenie

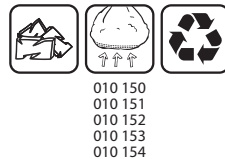



010 150
010 151
010 152
010 153
010 154



WORKI PRZEMYSŁOWE NIEBIESKIE 10 szt.

Rubble sacks (10 pcs) • Промышленные мешки (10 шт.)
• Schwergutsäcke (10 Stück) • Saci pentru moloz (10 bucati)

NUMER KATALOGOWY			
010 160	70x110 cm	120 L	1/30
010 161	120x140 cm	240 L	1/20

motive
Jakość ma znaczenie







010 161



WORKI POLIPROPYLENOWE

PP (polipropylene woven) bags • Мешки полипропиленовые
• PP- Gewebesack • Saci de rafie

NUMER KATALOGOWY				
010 228	25 kg	500 mm	880 mm	1/100/1000
010 229	50 kg	650 mm	1050 mm	1/100/1000



BIG BAG

Big bag • Мешок Big bag • BIG BAG • Saci de rafie Big Bag

NUMER KATALOGOWY			
010 251	1000 kg	90 x 90 x 100 cm	1



ODZIEŻ ROBOCZA I ARTYKUŁY BHP

WORKWEAR AND SAFETY ARTICLES • СПЕЦОДЕЖДА И СТАТЬИ ПО БЕЗОПАСНОСТИ

• ARBEITSKLEIDUNG UND SICHERHEITSARTIKEL • ARTICOLE DE ÎMBRĂCĂMINTE DE LUCRU ȘI DE SIGURANȚĂ





HDPE CAT. II

KASK OCHRONNY

Protective helmet • Защитный шлем • Schutzhelm • Casca de protectie

NUMER KATALOGOWY			
010 335		53-61 cm	1/50
010 337		53-61 cm	1/50
010 336		53-61 cm	1/50



HDPE CAT. II

KASK OCHRONNY EVO2

Protective helmet EVO2 • Защитный шлем EVO2 • Schutzhelm EVO2
• Casca de protectie EVO2

NUMER KATALOGOWY			
010 361	niebieski/blue	53-64 cm	1/10



ZATYCZKI 200x2 szt.

Ear plugs • Тапи за уши • Ohrstöpsel • Dopuri urechi

NUMER KATALOGOWY	
010 500	1/10



NAUSZNIKI OCHRONNE

Earmuffs • Наушники противозумные • Kapselgehörschutz
• Casti antifon cu banda de prindere pe cap

NUMER KATALOGOWY	
010 357	1/50



GOGLE GOSPODARCZE

Protective goggles • Защитные очки • Apsauginiai akiniai • Schutzbrille
• Ochelari de protectie universala cu aerisire indirecta

NUMER KATALOGOWY	
010 355	1/200



OKULARY OCHRONNE LAW-S

Protective spectacles LAW-S • Защитные очки LAW-S • Schutzbrille LAW-S
 • Ochelari de protectie LAW-S

NUMER
KATALOGOWY



010 352

1/10/120



OKULARY OCHRONNE LAW-T

Protective spectacles LAW-T • Защитные очки LAW-T • Schutzbrille LAW-T
 • Ochelari de protectie LAW-T

NUMER
KATALOGOWY



010 353

1/10

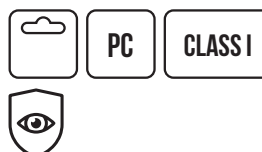

OKULARY OCHRONNE KALAHARI

Protective spectacles KALAHARI • Защитные очки KALAHARI
 • Schutzbrille KALAHARI • Ochelari de protectie KALAHARI

NUMER
KATALOGOWY



010 378

1

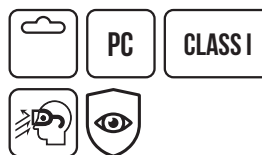

OKULARY OCHRONNE

Safety spectacles • Защитные очки • Besucherbrille
 • Ochelari de protectie universala

NUMER
KATALOGOWY



010 354

1/10/200



OKULARY OCHRONNE REGULOWANE

Adjustable safety spectacles • Защитные очки, регулируемые
 • Schutzbrille, verstellbar • Ochelari de protectie universala
 cu lentile incolore si brate ajustabile

NUMER
KATALOGOWY



010 342

1/10/200





PRZYŁBICA OCHRONNA

Protective visor • Защитный козырек для лица • Gesichtsschutz schutzvisier
• Vizieră de protecție

NUMER
KATALOGOWY



010 362

1/60



motive
Jakość ma znaczenie



MASKI PRZECIWPYŁOWE

Dust masks • Респиратор • Staubschutzmaske • Masca protectie praf

NUMER
KATALOGOWY



010 350

FFP1 (10)

10/20/400

010 440

FFP1 (3)

3/21/420



motive
Jakość ma znaczenie



PÓŁMASKI PRZECIWPYŁOWE Z ZAWORKIEM

Dust mask with valve • Респиратор с клапаном • Staubschutzmaske
• Masca protectie praf

NUMER
KATALOGOWY



010 351

FFP1 (10)

10/400

010 441

FFP1 (3)

3/21/420

010 349

FFP2 (10)

10/400

010 442

FFP2 (3)

3/21/420



POLYESTER



KAMIZELKA ODBLASKOWA

Hi-viz vest • Светоотражающая жилетка • Reflexion Weste
• Vesta de semnalizare galbena

NUMER
KATALOGOWY



010 330



XXL

1/100

010 331



XXL

1/100

010 430



XXXL

1/100

010 431



XXXXL

1/100



PVC + POLYESTER



KURTKA PRZECIWDESZCZOWA

Rain jacket • Куртка-дождевик • Regenjacke • Jacheta ploaie din PVC

NUMER
KATALOGOWY



010 259

L

1/20

010 270

XL

1/20

010 271



XXL

1/20



PŁASZCZ PRZECIWDDESZCZOWY

Raincoat • Плащ дождевик • Regenmantel • Pelerina ploaie din PVC galben

NUMER KATALOGOWY		
010 358	L	1/20
010 359	XL	1/20
010 360	XXL	1/10

PVC + POLYESTER



KOMBINEZON MALARSKI

Polypropylene Coverall • Комбинезон малярный • Schutzanzug, Polypropylen
 • Combinezon de protectie de unica folosinta din polipropilena

NUMER KATALOGOWY		
010 356	XXL	1/50
010 368	XXXL	1/50



SZELKI BEZPIECZEŃSTWA

Safety harness • Страховочная система • Auffanggurt • Centura siguranta

NUMER KATALOGOWY	
010 400	1/20

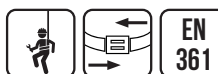

AMORTYZATOR DO SZELEK



Shock absorbing lanyard • Амортизатор для страховочной системы
 • Bandfalldämpfer • Banda de sustinere, cu amortizor

NUMER KATALOGOWY	
010 401	1/20



RĘKAWICE GRIPSTER (10 szt.)

Nitrile gloves GRIPSTER (10 pcs) • Нитриловые перчатки GRIPSTER (10 шт.)
 • Nitrilhandschuhe Gripster (10 Stück) • Manusi de protectie Gripster (10 bucati)

NUMER KATALOGOWY		
010 405	L	1/15/90
010 406	XL	1/15/90





NITRILE



RĘKAWICE GRIPSTER (50 szt.)

Nitrile gloves GRIPSTER (50 pcs) • Нитриловые перчатки GRIPSTER (50 шт.) • Nitrilhandschuhe GRIPSTER (50 Stück)
• Manusi de protectie Gripster (50 bucati)

NUMER KATALOGOWY		
010 332	S	1/10
010 327	M	1/10
010 328	L	1/10
010 329	XL	1/10
010 326	XXL	1/10



NITRILE



RĘKAWICE GRIPSTER BLACK (50 szt.)

Nitrile gloves GRIPSTER BLACK (50 pcs) • Нитриловые перчатки GRIPSTER BLACK (50 шт.) • Nitrilhandschuhe GRIPSTER BLACK (50 Stück)
• Manusi de protectie Gripster, neagra (50 bucati)

NUMER KATALOGOWY		
010 505	S	1/10
010 506	M	1/10
010 507	L	1/10
010 508	XL	1/10
010 509	XXL	1/10



LATEX



RĘKAWICE LATEKS (100 szt.)

Latex gloves (100 pcs) • Перчатки из латекса (100 шт.) • Voll-Latex-Einmal-Handschuhe (100 Stück) • Manusi universale din latex (100 bucati)

NUMER KATALOGOWY		
010 316	XL	1/10
010 317	S	1/10
010 318	M	1/10
010 319	L	1/10



NITRILE



RĘKAWICE NITRYL (100 szt.)

Latex gloves (100 pcs) • Перчатки из латекса (100 шт.) • Voll-Latex-Einmal-Handschuhe (100 Stück) • Manusi universale din latex (100 bucati)

NUMER KATALOGOWY		
010 291	S	1/10
010 292	M	1/10
010 293	L	1/10
010 294	XL	1/10



LATEX



RĘKAWICE LATEKS THICK (100 szt.)



Latex gloves (100 pcs) • Перчатки из латекса (100 шт.) • Voll-Latex-Einmal-Handschuhe (100 Stück) • Manusi universale din latex (100 bucati)

NUMER KATALOGOWY		
010 296	M	1/10
010 297	L	1/10
010 298	XL	1/10



RĘKAWICE NITRYLOWE

Nitrile gloves • Нитриловые перчатки • Nitrilhandschuhe • Manusi nitril

NUMER KATALOGOWY		
010 490	S	1/10
010 491	M	1/10
010 492	L	1/10
010 493	XL	1/10
010 494	XXL	1



NITRILE



RĘKAWICE FOLIOWE

Plastic disposable gloves • Фольгированные перчатки
 • Plastik Einweghandschuhe • Manusi folie



NUMER KATALOGOWY		
010 495	L	1/100

HDPE



RĘKAWICE GOSPODARCZE

Household latex gloves • Перчатки хозяйственные резиновые
 • Voll-Latex-Handschuhe • Manusi pentrua menaj din latex

NUMER KATALOGOWY		
010 310	S	12/240
010 323	M	12/240
010 324	L	12/240
010 325	XL	12/240

LATEX



RĘKAWICE SUPER TECH BLUE FIX

Working gloves SUPER TECH BLUE FIX • Перчатки SUPER TECH BLUE FIX
 • Handschuhe SUPER TECH BLUE FIX • Manusi de protectie SUPER TECH BLUE FIX

NUMER KATALOGOWY		
010 300	10	12

POLYESTER



RĘKAWICE BAWĘLNIANE POWLEKANE LATEKSEM

Cotton gloves latex coated • Перчатки ВАМПИР • Arbeitshandschuhe
 Baumwolle PVC Bezug • Manusi de protectie, din tricot + latex

NUMER KATALOGOWY		
010 301	10	10/600

BAWEŁNA
COTTON

LATEX







BAWEŁNA
COTTON

LATEX

RĘKAWICE POWLEKANE LATEKSEM

Cotton gloves latex coated • Перчатки пропитанные латексом
• Latex-Strickhandschuhe • Manusi de protectie, imersat in latex

NUMER KATALOGOWY		
010 347	9	12/240
010 307	10	12/240
010 348	11	12/240





POLYESTER

NITRILE

RĘKAWICE POWLEKANE NITRYLEM

Nitrile covered working gloves • Перчатки пропитанные нитрилом
• Nitrilhandschuhe • Manusi de protectie, impregnate cu nitril

NUMER KATALOGOWY		
010 304	9	12/240
010 334	10	12/240
010 333	11	12/240





NYLON

POLYURETHANE

RĘKAWICE POLIURETANOWE

Polyurethane covered working gloves • Перчатки полиуретановые
• Nylon-PU-Handschuhe • Manusi de protectie, imersate in poliuret看, albe



NUMER KATALOGOWY		
010 340	9	12/240
010 312	10	12/120
010 341	11	12/240



LATEX

RĘKAWICE DRAGOTEX

Latex coated working gloves DRAGOTEX • Перчатки DRAGOTEX
• Latex Strickhandschuhe Dragotex • Manusi de protectie Dragotex

NUMER KATALOGOWY		
010 308	9	12/240
010 338	10	12/240
010 339	11	12/240





POLYESTER

LATEX

RĘKAWICE GRIPEX

Latex coated working gloves GRIPEX • Перчатки GRIPEX
• Latex Strickhandschuhe GRIPEX • Manusi de protectie Gripex

NUMER KATALOGOWY		
010 379	10	12/240



RĘKAWICE SPAWALNICZE CZERWONE

Welding gloves • Перчатки сварщика • Suvirintojo pirštinės
 • Schweißer Handschuhe • Mănuși de sudură

NUMER
KATALOGOWY

010 290



1/12/60



RĘKAWICE OILMAX

PVC coated gloves • Перчатки масло-бензостойкие • PVC Handschuhe
 • Manusi de protectie, din bumbac + pvc

NUMER
KATALOGOWY

010 306



10



12/120

BAWEŁNA
COTTON

LATEX



RĘKAWICE GRIP

Rubber coated working gloves • Перчатки прорезиненные "Grip"
 • Latex-Handschuhe mit Baumwollfutter • Manusi de protectie Grip

NUMER
KATALOGOWY

010 305



10



12/120

GUMA
RUBBER



RĘKAWICE EXTRA GRIP

Insulated working gloves EXTRA GRIP • Перчатки EXTRA GRIP
 • Handschuhe EXTRA GRIP • Manusi de protectie Extra Grip

NUMER
KATALOGOWY

010 311



10



12/120

motive
Jakość ma znaczenie

GUMA
RUBBER



RĘKAWICE ARMOR

Working gloves ARMOR with anticut fibres • Перчатки ARMOR
 • Handschuhe ARMOR • Manusi de protectie Armor

NUMER
KATALOGOWY

010 372



10



1/12/120

motive
Jakość ma znaczenie





motive
Jakość ma znaczenie



POLYESTER

NITRILE

RĘKAWICE MECHANIC

Heavy duty nitrile coated working gloves • Перчатки MECHANIC

- Montagehandschuhe- Nitril + Polyester
- Manusi de protectie, impregnate cu nitril

NUMER KATALOGOWY		
010 371	10	1/12/120
010 370	11	1/12/120





motive
Jakość ma znaczenie

SKÓRA
LEATHER

RĘKAWICE TRUCKER

Cow grain leather working gloves • Перчатки TRUCKER • Nappaleder-Handschuhe TRUCKER • Manusi de protectie, din piele fina de bovina

NUMER KATALOGOWY		
010 374	9	1/12/120
010 375	10	1/12/120



motive
Jakość ma znaczenie

LATEX



RĘKAWICE ARCTIC OCIEPLANE

Latex coated terry inside working gloves • Перчатки утепленные ARCTIC • Winter Arbeitshandschuhe Gefüttert ARCTIC • Manusi de protectie Arctic

NUMER KATALOGOWY		
010 309	10	12/120



motive
Jakość ma znaczenie



NAKOLANNIKI

Knee pads • Наколенники • Knieschoner • Genunchiere de protectie

NUMER KATALOGOWY	
010 367	1/24



GUMA
RUBBER



NAKOLANNIKI GUMOWE

Rubber knee pads • Резиновые наколенники • Knieschoner aus Gummi • Genunchiere de protectie

NUMER KATALOGOWY	
010 365	1/12/24



NAKOLANNIKI PIANKOWE

PU foam knee-pads • Наколенники на пенной основе • Knieschoner aus weichem Schaum • Genunchiere de protectie din material EVA

NUMER
KATALOGOWY



010 366

1/50

EVA



NAKOLANNIKI

NAKOLANNIKI OCHRONNE MOTIVE przydatne do wszelkich prac wykonywanych w pozycji klęczącej. Ich dopracowany kształt powoduje, że idealnie rozkładają siłę nacisku, przez co dłuższa praca na klęczkach nie staje się męcząca i uciążliwa. Szerokie i elastyczne paski łączone przy pomocy rzepów dopasowują się do każdego kolana. Nakolanniki znajdują zastosowanie podczas prac brukarskich, monterskich, ogrodniczych, czy dekarских.



Nr kat. 010 367

Wszyta w nakolannik
żelowa warstwa ochronna

Szerokie i elastyczne paski
z mocnymi rzepami
mocującymi

Wyściółka
z wygodnej pianki
ochronnej

Wodoodporna i mocna
tkanina poliestrowa, odporna
na przedarcia i plamy

Dobrze wyprofilowana
i elastyczna miseczka ochronna

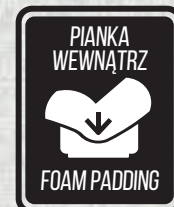

NAKOLANNIKI OCHRONNE MOTIVE

- ✓ dedykowane do wielu podłoży
- ✓ przeznaczone do pracy w trudnych warunkach
- ✓ o wysokim komforcie użytkowania
- ✓ zapewniające pełną swobodę ruchów
- ✓ atestowane, spełniające normę EN 14404
- ✓ jeden uniwersalny rozmiar

CE EN 14404:2004+A1:2010
Knee pads Art. DFT026



O SZCZEGÓŁY I DOSTĘPNOŚĆ
ZAPYTAJ HANDLOWCĄ W TWOIM REGIONIE



tested to work

SPODNI ADVANCED

Z KIESZENIAMI NA KOLANACH

to wysokiej jakości spodnie robocze, wykonane z lekkiego a jednocześnie wytrzymałego materiału streczowego. W połączeniu z wodoodpornym wykończeniem zapewniają użytkownikowi niezrównaną swobodę ruchu, bez ucisku i ocierania. Kieszenie na kolanach dostosowane są do umieszczenia w nich nakolanników, co świetnie sprawdzi się podczas długiej pracy w pozycji klęcznej. Dyskretne paski odblaskowe na bokach nogawek zapewnią dodatkowe bezpieczeństwo podczas pracy w warunkach słabego oświetlenia.

Mocne szlufki do paska, w tym szeroka szlufka z tyłu

Obniżona talia

Materiał streczowy Ultimate Stretch, rozciągliwy we wszystkich kierunkach

Rozporek zapinany na zamek błyskawiczny

Podwójne szwy

Zapinane boczne kieszenie, w tym kieszonka na udzie, na telefon

Kieszenie na kolanach, wykonane z wytrzymałego materiału CORDURA® do łatwego wkładania dedykowanych wkładek ochronnych (Waterloo)

Skuteczna wentylacja w okolic kolan, dzięki zamkowi błyskawicznemu

Elementy odblaskowe dla bezpieczeństwa w warunkach słabego oświetlenia

Odpowiednio skrojone, ergonomiczne nogawki

ULTIMATE
STRETCH
WORKWEAR

CORDURA
BRAND
F A B R I C



O SZCZEGÓŁY I DOSTĘPNOŚĆ
ZAPYTAJ HANDLOWCĘ W TWOIM REGIONIE



tested to work

SPODNI TEMORA

Z KIESZENIAMI NA KOLANACH

to wysokiej jakości spodnie robocze o ergonomicznym kroju. Wytrzymałe potrójne szwy gwarantują długą żywotność. Nogawki zostały skrojone z tyłu dzięki czemu nadmiar materiału nie przeszkadza podczas pracy. Kieszenie na kolanach dostosowane są do umieszczenia w nich nakolanników, co świetnie sprawdzi się podczas długiej pracy w pozycji klęcznej. Dyskretne paski odblaskowe z tyłu nogawek zapewnią dodatkowe bezpieczeństwo podczas pracy w warunkach słabego oświetlenia.

Mocne szlufki do paska

Rozporek zapinany na zamek błyskawiczny

Potrójne szwy

Zapinane boczne kieszenie,
w tym kieszonka na udzie, na telefon

Kieszenie na kolanach, do łatwego wkładania
dedykowanych wkładek ochronnych (SHORT lub LONG)

Ciemna tkanina umieszczona w miejscach
najbardziej narażonych na zabrudzenie

Elementy odblaskowe dla bezpieczeństwa
w warunkach słabego oświetlenia

Skrojone z tyłu, ergonomiczne nogawki











































O SZCZEGÓŁY I DOSTĘPNOŚĆ
ZAPYTAJ HANDLOWCĘ W TWOIM REGIONIE



SPODNIE ADVANCED

Trousers with kneepad pockets Advanced • Брюки с карманами для наколенников Advanced • Hose mit Knietaschen Advanced • Pantaloni cu buzunare pentru genunchi Advanced

NUMER KATALOGOWY			
17179-311-06-82C46		82/46	1
17179-311-06-82C48		82/48	1
17179-311-06-82C50		82/50	1
17179-311-06-82C52		82/52	1
17179-311-06-82C54		82/54	1
17179-311-06-82C56		82/56	1
17179-311-06-82C58		82/58	1
17179-311-06-82C60		82/60	1
17179-311-18-82C46		82/46	1
17179-311-18-82C48		82/48	1
17179-311-18-82C50		82/50	1
17179-311-18-82C52		82/52	1
17179-311-18-82C54		82/54	1
17179-311-18-82C56		82/56	1
17179-311-18-82C58		82/58	1
17179-311-18-82C60		82/60	1
17179-311-18-90C48		90/48	1
17179-311-18-90C50		90/50	1
17179-311-18-90C52		90/52	1
17179-311-18-90C54		90/54	1
17179-311-18-90C56		90/56	1
17179-311-18-90C58		90/58	1
17179-311-33-82C48		82/48	1
17179-311-33-82C50		82/50	1
17179-311-33-82C52		82/52	1
17179-311-33-82C54		82/54	1
17179-311-33-82C56		82/56	1
17179-311-44-82C46		82/46	1
17179-311-44-82C48		82/48	1
17179-311-44-82C50		82/50	1
17179-311-44-82C52		82/52	1
17179-311-44-82C54		82/54	1
17179-311-44-82C56		82/56	1
17179-311-55-82C48		82/48	1
17179-311-55-82C50		82/50	1
17179-311-55-82C52		82/52	1
17179-311-55-82C54		82/54	1
17179-311-55-82C56		82/56	1

SPODNIE TEMORA

Trousers with kneepad pockets Temora • Брюки с карманами для наколенников Temora • Hose mit Knietaschen Temora • Pantaloni cu buzunare pentru genunchi

NUMER KATALOGOWY		
15779-330-1809-82C46	82/46	1
15779-330-1809-82C48	82/48	1
15779-330-1809-82C50	82/50	1
15779-330-1809-82C52	82/52	1
15779-330-1809-82C54	82/54	1
15779-330-1809-82C56	82/56	1
15779-330-1809-82C58	82/58	1
15779-330-1809-82C60	82/60	1



tested to work

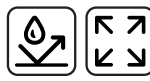

tested to work





tested to work

BLUZA POLAROWA ACCELERATE

to wysokiej jakości bluza z miękkiego polaru. Zapewnia doskonałą ochronę przed wiatrem i zimnem jednocześnie pozwalając skórze oddychać. Gładkie wykończenie sprawia, że brud i pył nie osiada na powierzchni bluzy. Ergonomiczny krój zapewnia swobodę ruchów w każdych warunkach. Pojemne kieszenie na bokach i klatce piersiowej pozwalają mieć najważniejsze rzeczy zawsze przy sobie. Dyskretne paski odblaskowe na bokach zapewnią dodatkowe bezpieczeństwo podczas pracy w warunkach słabego oświetlenia.

Elastyczny, przylegający do szyi wysoki kołnierz

Kieszeń na piersi zapinana na zamek błyskawiczny

Zapięcie na suwak z wewnętrzną klapką sztormową

Gładka powierzchnia zapobiegająca osiadaniu brudu i pyłu

Dopasowany krój

Gumki w mankietach i pasie

Elementy odblaskowe dla bezpieczeństwa w warunkach słabego oświetlenia



**O SZCZEGÓŁY I DOSTĘPNOŚĆ
ZAPYTAJ HANDLOWCĘ W TWOIM REGIONIE**



SPODNIЕ CLASSIC MAXIMUS

Classic Maximus pants • Брюки Classic Maximus • Hose Classic Maximus
• Pantaloni Classic Maximus

NUMER KATALOGOWY		
010 611	44	1/20
010 612	46	1/20
010 613	48	1/20
010 614	50	1/20
010 615	52	1/20
010 616	54	1/20
010 617	56	1/20
010 618	58	1/20
010 619	60	1/20
010 620	62	1/20
010 621	64	1/20



BLUZA POLAROWA ACCELERATE

Fleece Jumper with zipper Accelerate • Толстовка из флиса
• Fleecepullover mit Reißverschluss Accelerate • Hanorac din fleece Accelerate

NUMER KATALOGOWY		
18103-316-1809-S	S	1
18103-316-1809-M	M	1
18103-316-1809-L	L	1
18103-316-1809-XL	XL	1
18103-316-1809-2XL	2XL	1
18103-316-1809-3XL	3XL	1



tested to work



KURTKA CLASSIC MAXIMUS

Classic Maximus jacket • Куртка Classic Maximus • Jacke Classic Maximus
• Jacheta Classic Maximus

NUMER KATALOGOWY		
010 600	44	1/20
010 601	46	1/20
010 602	48	1/20
010 603	50	1/20
010 604	52	1/20
010 605	54	1/20
010 606	56	1/20
010 607	58	1/20
010 608	60	1/20
010 609	62	1/20
010 610	64	1/20



KOSZULA MODAR

Modar shirt • Рубашка Modar • Hemd Modar • Cămașă Modar

NUMER KATALOGOWY		
010 622	39	1/50
010 623	40	1/50
010 624	41	1/50
010 625	42	1/50
010 626	43	1/50
010 627	44	1/50
010 628	45	1/50
010 629	46	1/50





tested to work



KAMIZELKA ZIMOWA ACCELERATE

Winter Gilet Accelerate • Зимний жилет Accelerate • Winterweste Accelerate
• Vestă de iarnă Accelerate

NUMER KATALOGOWY		
18065-318-1809-S	S	1
18065-318-1809-M	M	1
18065-318-1809-L	L	1
18065-318-1809-XL	XL	1
18065-318-1809-2XL	2XL	1
18065-318-1809-3XL	3XL	1



tested to work



T-SHIRT ACCELERATE

NUMER KATALOGOWY		
18382-959-1809-S	S	1
18382-959-1809-M	M	1
18382-959-1809-L	L	1
18382-959-1809-XL	XL	1
18382-959-1809-2XL	2XL	1
18382-959-1809-3XL	3XL	1



tested to work



NAKOLANNIKI WATERLOO

Kneepads Waterloo • Наколенники Waterloo • Knieschutz Waterloo
• Genunchiere Waterloo

NUMER KATALOGOWY	
00718-100-08	1



tested to work

KIESZENIE WISZĄCE BENONI

Holster Pockets Benoni • Подвесные карманы Benoni • Hängetaschen Benoni
• Toc pentru scule Benoni

NUMER KATALOGOWY	
11011-012-09	1



tested to work



PASEK

Belt • Пояс • Gürtel • Centura

NUMER KATALOGOWY		
17044-990-09	130 cm	1



tested to work

OBUWIE OCHRONNE FLEX

to profesjonalne buty robocze odpowiednie do pracy w każdych warunkach. Lekki i elastyczny materiał zapewnia komfort pracy. Kompozytowy podnosek odporny jest na uderzenie i nacisk równy 200 dżułom. Wygodna absorbująca wstrząsy wkładka optymalnie wspiera sklepienie zmniejszając tendencję do powstawania płaskostopia. Antyprzebiciowa podeszwa odporna jest na działanie oleju i benzyny jak również temperatury do 140°C. Praktyczne zaczepy ułatwiają poruszanie się po nierównych podłożach i pracę na drabinach.

Antypoślizgowy zaczep drabinowy

Podeszwa odporna na temperatury do 140°C

Antyprzebiciowa podeszwa odporna na benzynę i olej

Absorbująca wstrząsy wkładka

Wodoodporny materiał

Stabilizujący wielofunkcyjny przegub

Elastyczna przednia część obuwia

Nosek wzmocniony TPU



O SZCZEGÓŁY I DOSTĘPNOŚĆ
ZAPYTAJ HANDLOWCĘ W TWOIM REGIONIE



tested to work



OBUWIE OCHRONNE FLEX

Safety shoes Flex • Спецобувь Flex • Sicherheitsschuhe Flex
• Pantofi de protectie Flex

NUMER KATALOGOWY		
F0121-770-09880-1039	39	1
F0121-770-09880-1040	40	1
F0121-770-09880-1041	41	1
F0121-770-09880-1042	42	1
F0121-770-09880-1043	43	1
F0121-770-09880-1044	44	1
F0121-770-09880-1045	45	1
F0121-770-09880-1046	46	1
F0121-770-09880-1047	47	1
F0121-770-09880-1048	48	1

BUTY OCHRONNE BTEX SB

Safety shoes Btex SB • Спецобувь Btex SB • Sicherheitsschuhe Btex SB
• Pantofi de protectie Btex SB

NUMER KATALOGOWY		
010 739	39	1/10
010 740	40	1/10
010 741	41	1/10
010 742	42	1/10
010 743	43	1/10
010 744	44	1/10
010 745	45	1/10
010 746	46	1/10
010 747	47	1/10

BUTY SANDAŁY BSSB

Safety sandals • Сандалии рабочие • Sicherheitssandalen • Sandale sigure

NUMER KATALOGOWY		
010 839	39	1/10
010 840	40	1/10
010 841	41	1/10
010 842	42	1/10
010 843	43	1/10
010 844	44	1/10
010 845	45	1/10
010 846	46	1/10
010 847	47	1/10



BUTY CHODAKI

Garden clogs • Сабо • Gartenschuhe • Saboți

NUMER KATALOGOWY		
010 939	39	1/24
010 940	40	1/24
010 941	41	1/24
010 942	42	1/24
010 943	43	1/24
010 944	44	1/24
010 945	45	1/24



KALOSZE - BUTY BPCV

Wellington boots • Сапоги • Gummistiefel • Cizme



NUMER KATALOGOWY		
010 639	39	1/10
010 640	40	1/10
010 641	41	1/10
010 642	42	1/10
010 643	43	1/10
010 644	44	1/10
010 645	45	1/10
010 646	46	1/10
010 647	47	1/10

TABELA ROZMIARÓW



SPODNIE ADVANCED - Trousers with kneepad pockets Advanced

- Брюки с карманами для наколенников Advanced
- Hose mit Knietaschen Advanced
- Pantaloni cu buzunare pentru genunchi Advanced

	E - cm	L - cm
82/46	82	78
82/48	82	83
82/50	82	88
82/52	82	93
82/54	82	98
82/56	82	103
82/58	82	108
82/60	82	113

SPODNIE TEMORA - Trousers with kneepad pockets Temora

- Брюки с карманами для наколенников Temora
- Hose mit Knietaschen Temora
- Pantaloni cu buzunare pentru genunchi Temora

	E - cm	L - cm
82/46	82	78
82/48	82	83
82/50	82	88
82/52	82	93
82/54	82	98
82/56	82	103
82/58	82	108
82/60	82	113

SPODNIE CLASSIC MAXIMUS - Classic Maximus pants

- Брюки Classic Maximus • Hose Classic Maximus
- Pantaloni Classic Maximus

	F - cm	L - cm
82/46	171	80-84
82/48	174	84 - 88
82/50	177	88 - 92
82/52	180	92 - 98
82/54	182	98 - 102
82/56	184	102 - 108
82/58	186	108 - 112
82/60	188	114 - 118

KURTKA CLASSIC MAXIMUS - Classic Maximus jacket

- Куртка Classic Maximus • Jacke Classic Maximu
- Jacheta Classic Maximus

	F - cm	A - cm
44	167	86 - 90
46	171	90 - 94
48	174	94 - 98
50	177	98 - 102
52	180	102 - 108
54	182	108 - 112
56	184	112 - 118
58	186	118 - 122
60	188	124 - 128
62	193	128 - 132
64	197	132 - 138

KOSZULA MODAR - Modar shirt • Рубашка Modar • Hemd Modar • Cămașă Modar

	39	40	41	42	43	44	45	46
A - cm	114	118	122	126	130	134	138	142
B - cm	78	78	80	80	82	82	84	86
C - cm	50	50	52	52	54	54	56	56
D - cm	62	62	64	64	66	66	68	68
F - cm	164 - 170	164 - 170	170 - 176	170 - 176	176 - 182	176 - 182	182 - 188	182 - 188

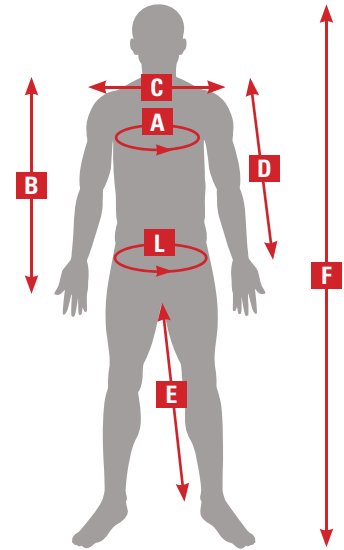

BLUZA POLAROWA ACCELERATE - Fleece Jumper with zipper Accelerate • Толстовка из флиса • Fleecepullover mit Reißverschluss Accelerate • Hanorac din fleece Accelerate

	A - cm
S	92
M	100
L	104
XL	112
2XL	116
3XL	124

KAMIZELKA ZIMOWA ACCELERATE - Winter Gilet Accelerate

- Зимний жилет Accelerate • Winterweste Accelerate
- Vestă de iarnă Accelerate

	A - cm
S	92
M	100
L	104
XL	112
2XL	116
3XL	124

TAŚMY

ЛЕНТЫ • TAPES • BÄNDER BENZI • ADEZIVE



SPECYFIKACJA WYBRANYCH TAŚM



	BLUE MASKING	WHITE MASKING	MASKUJĄCA PRECYZYJNA	LAKIERNICZA	DELIKATNA
	Najpopularniejsza taśma maskująca od Motive. Skutecznie zabezpiecza ściany, ramy okienne, listwy przypodłogowe, narożniki, a także krawędzie ścian i sufitów. Wyróżnia się bardzo dobrymi właściwościami klejącymi. Zero podciekania podczas malowania lub odcinania kolorów.	Taśma maskująca, dzięki której wykleisz idealne luki czy nawet okregi. Wykonana jest z papieru krepowanego. Wyróżnia się bardzo dobrymi właściwościami klejącymi, jednocześnie nie pozostawiając śladów kleju po jej zerwaniu.	Taśma dedykowana do klejenia na bardziej wymagające powierzchnie. Idealnie dopasowuje się do wszelkich wyklejanych kształtów. Poza klasycznym malowaniem pędzlem lub wałkiem, można wykorzystać ją w czasie malowania natryskowego.	Taśma wykonana z papieru ryżowego odpornego na wilgoć. Mocny klej idealnie sprawdzi się podczas malowania natryskowego, gdzie istnieje ryzyko poderwania farby. Jednocześnie łatwo ją usunąć, a ponadto nie pozostawia śladów kleju.	Taśma przydatna wtedy, gdy nie mamy pewności jak zostało wcześniej przygotowane nasze podłoże. Delikatny klej zmniejsza ryzyko oderwania taśmy razem z farbą czy tynkiem. Klej jest jednocześnie na tyle mocny, aby bez problemu utrzymać się na ścianie.
Długość	25, 50 m	50 m	50 m	50 m	50 m
Szerokość	18, 25, 30, 38, 48 mm	18, 30, 38, 48 mm	11, 15, 25, 30, 38, 48 mm	25, 30, 38, 48 mm	30, 38, 48 mm
Gdzie stosować?	Wewnątrz i na zewnątrz (ściany, ramy okienne, listwy przypodłogowe, narożniki, krawędzie ścian oraz sufitów)	Wewnątrz i na zewnątrz (ściany, ramy okienne, listwy przypodłogowe, narożniki, krawędzie ścian oraz sufitów)	Wewnątrz i na zewnątrz	Wewnątrz i na zewnątrz (prace lakiernicze)	Wewnątrz i krótkotrwałe na zewnątrz (listwy, ramy okienne, płyty meblowe, tworzywa sztuczne, szyby)
Kiedy zrywać?	Po wyschnięciu farby i taśmy (maksymalnie 14 dni na zewnątrz lub 30 dni wewnątrz)	Po wyschnięciu farby i taśmy (maksymalnie 3 dni na zewnątrz lub 7 dni wewnątrz)	Po wyschnięciu farby i taśmy (maksymalnie 7 dni na zewnątrz lub 21 dni wewnątrz)	Po wyschnięciu farby i taśmy (maksymalnie 21 dni)	Po wyschnięciu farby i taśmy





	WODOODPORNĄ DELIKATNA	PROMASK	UV-PE	TYNKARSKA	PVC KARBOWANA LUB GŁADKA
	Taśma, która nadaje się do przyklejenia na ledwo przeschniętą farbę. Przywiera bardzo delikatnie. Jej nośnik to folia z paskami kleju. Dodatkowo przylega do powierzchni, również na zasadzie elektrostatyki.	Taśma wzmocniona drobną siatką z włókna, dzięki temu nie zmienia kształtu podczas przypadkowego sklejania się. Jednocześnie łatwo przerywa się pod kątem 90°.	Taśma wykonana z folii PE do zabezpieczenia powierzchni wewnątrz, jak i na zewnątrz. Jest odporna na promieniowanie UV i dlatego może być ekspozowana na zewnątrz nawet do 30 dni, bez obaw o utratę jej właściwości.	Taśma przeznaczona do zabezpieczenia powierzchni podczas prac tynkarskich i budowlanych. Jest niewrażliwa na warunki atmosferyczne. Taśma o wielu zastosowaniach na placu budowy, w tym również jako taśma reperacyjna.	Taśmy maskujące wykonane z PVC. Polecane do prac malarskich i lekkich budowlanych wewnątrz, jak i na zewnątrz. Taśmy są odporne na wilgoć i przy krótkim ekspozowaniu na promienie UV.
Długość	25 m	25, 50 m	25, 50 m	20, 50 m	25 m
Szerokość	25, 33, 50 mm	38, 48 mm	38 - 48 mm	38, 48 mm 25 mm - wersja do boni	38, 48 mm
Gdzie stosować?	Wewnątrz i na zewnątrz (na świeżą farbę i delikatne powierzchnie)	Wewnątrz i na zewnątrz (stolarstwo okienne, stal, aluminium, pcv, drewno, szkło)	Wewnątrz i na zewnątrz (metal, szkło, plastik, aluminium, drewno)	Wewnątrz i na zewnątrz (tynk, cegła, beton, drewno, pcv, kostka brukowa, powierzchnie gładkie i chropowate)	Wewnątrz i na zewnątrz (metal, szkło, plastik, aluminium, drewno)
Kiedy zrywać?	Od razu po malowaniu (maksymalnie po 30 dniach)	Najlepiej od razu po malowaniu lub tynkowaniu* (maksymalnie po 30 dniach)	Od razu po malowaniu lub tynkowaniu* (maksymalnie po 30 dniach)	Maksymalnie 14 dni na zewnątrz lub 21 dni wewnątrz	Od razu po malowaniu lub tynkowaniu* (maksymalnie 14 dni na zewnątrz lub 21 dni wewnątrz)

* taśmy nie należy zrywać w pełnym słońcu i z nagranych powierzchni



BLUE MASKING TAPE



Blue masking tape • Лента малярная "BLUE MASKING TAPE"
• Malercreppband blau • Banda mascare, rezistenta la UV, albastra

NUMER KATALOGOWY			
020 328	30 mm	25 m	36/3600
020 329	38 mm	25 m	1/24/2520
020 330	48 mm	25 m	1/24/2160
020 311	18 mm	50 m	1/48/2880
020 312	25 mm	50 m	48/2880
020 313	30 mm	50 m	36/3600
020 314	38 mm	50 m	24/2160
020 315	48 mm	50 m	24/2160



WHITE MASKING TAPE



White masking tape • Лента малярная "WHITE MASKING TAPE"
• Kreppband weiß • Banda mascare alb

NUMER KATALOGOWY			
020 334	18 mm	50 m	1/48/3600
020 331	30 mm	50 m	1/36/3600
020 332	38 mm	50 m	1/24/2160
020 333	48 mm	50 m	1/24/2160



TAŚMA DELIKATNA - LIGHT



Low tack tape • Лента малярная "LIGHT" • Abdeckband Low Tack
• Banda mascare, suprafete sensibilă

NUMER KATALOGOWY			
020 498	30 mm	50 m	1/48
020 499	38 mm	50 m	1/24
020 500	48 mm	50 m	1/24



TAŚMA MASKUJĄCA

Masking tape • Лента малярная на бумажной основе • Abdeckband
• Banda mascare interior

NUMER KATALOGOWY			
020 150	19 mm	25 m	48/4320
020 151	25 mm	25 m	36/3780
020 152	30 mm	25 m	40/3600
020 153	38 mm	25 m	24/2160
020 154	48 mm	25 m	24/2160
020 165	19 mm	50 m	48/4320
020 166	25 mm	50 m	36/3240
020 167	30 mm	50 m	40/3600
020 168	38 mm	50 m	24/2160
020 169	48 mm	50 m	24/2400





motive
Jakość ma znaczenie



TAŚMA MASKUJĄCA PRECYZYJNA

Precision masking tape • Точная защитная лента • Kreppband Washitape
• Banda de mascare Washi-Tape auriе

NUMER KATALOGOWY			
020 341	11 mm	50 m	1/96
020 346	15 mm	50 m	1/48
020 342	25 mm	50 m	1/48
020 343	30 mm	50 m	1/48
020 344	38 mm	50 m	1/24
020 345	48 mm	50 m	1/24



TAŚMA MASKUJĄCA BLUE

Masking tape • Лента клейк. на бумажной основе • Kreppband Blue • Banda mascare Blue

NUMER KATALOGOWY			
020 360	30 mm	50 m	40
020 361	38 mm	50 m	24
020 362	48 mm	50 m	24



motive
Jakość ma znaczenie



TAŚMA WODOODPORNĄ DELIKATNA

Waterproof masking tape- sensitive • Лента водонепроницаемая слабая
• Wasserbeständig malerband • Banda de mascare impermeabilă sensitiv

NUMER KATALOGOWY			
020 410	25 mm	25 m	8/1296
020 411	33 mm	25 m	6/1458
020 412	50 mm	25 m	4/1944



motive
Jakość ma znaczenie



TAŚMA WODOODPORNĄ MOCNA

Waterproof masking tape- strong • Лента водонепроницаемая крепкая
• Wasserbeständig malerband • Banda de mascare impermeabilă strong

NUMER KATALOGOWY			
020 420	25 mm	25 m	8
020 421	33 mm	25 m	6
020 422	50 mm	25 m	4



motive
Jakość ma znaczenie



TAŚMA PVC GŁADKA

Smooth surface pvc tape • Лента ПВХ гладкая • Glatt PVC Band
• Banda mascare PVC

NUMER KATALOGOWY			
020 203	30 mm	25 m	1/36/2880
020 204	38 mm	25 m	1/30/2400
020 205	48 mm	25 m	1/24/1920



TAŚMA PVC KARBOWANA

PVC easy tear tape, embossed • Лента ПВХ • Quervergillt PVC Band
• Banda mascare PVC alba

NUMER KATALOGOWY			
020 198	30 mm	25 m	1/36
020 199	38 mm	25 m	1/30
020 200	48 mm	25 m	1/24



TAŚMA UV-PE

Polyethylene masking tape • Лента UV-PE • UV-PE Band
• Banda mascare UV-PE

NUMER KATALOGOWY			
020 207	38 mm	50 m	1/32
020 208	48 mm	25 m	1/24
020 209	48 mm	50 m	1/24



TAŚMA PE PROMASK

PE Promask Tape • Лента "PE PROMASK" • Bautenschutzband PE
• Banda mascare textila PE

NUMER KATALOGOWY			
020 459	38 mm	50 m	1/24
020 457	48 mm	25 m	1/24
020 460	48 mm	50 m	1/24



TAŚMA DWUSTRONNA

Double sided adhesive tape, PE foil • Скотч 2-х.стор. на п/п основе
• Doppelseitiges Klebeband mit Folienträger • Banda dublu adeziva

NUMER KATALOGOWY			
020 125	38 mm	5 m	1/48
020 126	38 mm	10 m	1/48
020 128	50 mm	5 m	1/36
020 129	50 mm	10 m	1/36
020 130	50 mm	25 m	1/24



TAŚMA DWUSTRONNA WZMOCNIONA

Double sided adhesive tape, cloth • Скотч 2-х.стор. на тканевой основе
• Doppelseitiges Klebeband mit Gewebeträger
• Banda dublu adeziva, suport textil

NUMER KATALOGOWY			
020 120	50 mm	5 m	1/36
020 121	50 mm	10 m	1/36
020 122	50 mm	25 m	1/24





motive
Jakość ma znaczenie



TAŚMA LAKIERNICZA

Car painter's masking tape • Термостойкая малярная клейкая лента
• Lackierband • Banda adeziva pentru vopsitorii auto

NUMER KATALOGOWY			
020 140	25 mm	50 m	1/48
020 141	30 mm	50 m	1/36
020 142	38 mm	50 m	1/24
020 143	48 mm	50 m	1/24



motive
Jakość ma znaczenie



TAŚMA UNIWERSALNA

Duct tape, cloth • Лента универсальная • Reparaturband • Banda Duct Tape

NUMER KATALOGOWY			
020 210	50 mm	10 m	1/36
020 211	50 mm	25 m	1/24
020 212	50 mm	50 m	1/12



motive
Jakość ma znaczenie



TAŚMA UNIWERSALNA STRONG

Heavy duty duct tape • Лента универсальная "STRONG"
• Reparaturband Strong • Banda Duct Tape Strong

NUMER KATALOGOWY			
020 213	48 mm	25 m	1/24
020 214	48 mm	50 m	1/12



motive
Jakość ma znaczenie

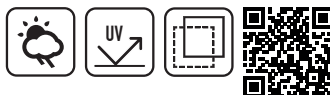

TAŚMA DO KLEJENIA FOLII

Joint tape for foils • Скотч для соединения плёнки • PE Reparaturband
• Banda adeziva pentru folie solar

NUMER KATALOGOWY			
020 454	48 mm	20 m	1/24



motive
Jakość ma znaczenie



TAŚMA DO MEMBRAN DACHOWYCH



Adhesive tape for roof membranes • Лента для мембран • Einseitiges Klebeband für Unterspannbahnen • Banda reparatii membrane acoperis

NUMER KATALOGOWY			
020 451	50 mm	25 m	1/6



TAŚMA TYNKARSKA

Plastering and roughcasting tape • Лента штукатурная • Putzband
• Banda adeziva pentru tencuieli

NUMER KATALOGOWY			
020 131	38 mm	20 m	1/24
020 132	48 mm	20 m	1/24
020 133	38 mm	50 m	1/28
020 134	48 mm	50 m	1/24



TAŚMA TYNKARSKA STRONG

Plastering and roughcasting tape • Лента штукатурная • Putzband
• Banda adeziva pentru tencuieli

NUMER KATALOGOWY			
020 033	38 mm	50 m	1/32
020 034	48 mm	50 m	1/24



TAŚMA TYNKARSKA DO BONI



Plastering tape for rustication • Лента для рустовки штукатурки
• Putzband • Banda adeziva pentru tencuieli

NUMER KATALOGOWY			
020 455	25 mm	50 m	1/48



TAŚMA ELEWACYJNA



Plastering tape for rustication • Лента для рустовки штукатурки
• Putzband • Banda adeziva pentru tencuieli

NUMER KATALOGOWY			
020 240	38 mm	20 m	1/24
020 241	48 mm	20 m	1/24
020 242	38 mm	50 m	1/28
020 243	48 mm	50 m	1/24
020 244	48 mm	50 y	1/24



TAŚMA ŁĄCZENIOWA

Drywall joint tape • Лента серпянка • Gitterband selbstklebend
• Banda autoadeziva pentru imbinare

NUMER KATALOGOWY			
020 111	50 mm	10 m	1/60
020 112	50 mm	20 m	1/60
020 113	50 mm	45 m	1/54
020 114	50 mm	90 m	1/24
020 115	50 mm	153 m	1/12
020 118	48 mm	82 m	1/24





motive
Jakość ma znaczenie

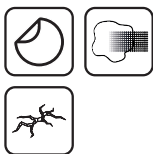

TAŚMA REPERACYJNA

Drywall joint tape • Лента ремонтная из стекловолокна
• Gitterband selbstklebend • Banda autoadeziva pentru imbinare

NUMER KATALOGOWY			
020 108	200 mm	20 m	1/12
020 109	100 mm	20 m	1/24
020 110	150 mm	20 m	1/24



motive
Jakość ma znaczenie



TAŚMA Z WŁÓKNA SZKLANEGO

Fiberglass tissue tape • Стеклохолст „Паутинка” • Glasfasermatte
• Banda fibra sticla pentru imbinare

NUMER KATALOGOWY			
020 226	1 m	25 m	25/100/2100



motive
Jakość ma znaczenie

TAŚMA Z WŁÓKNA SZKLANEGO

Fiberglass tissue tape • „Флизелин” - лента из стекловолокна для г/к несамокл • Glasfaserband • Banda fibra sticla pentru imbinare

NUMER KATALOGOWY			
020 225	50 mm	25 m	1/100/1300
020 224	150 mm	25 m	1/50



motive
Jakość ma znaczenie



TAŚMA ŚLIZGOWA

Plasterboard tape • Лента разделительная • Trennband • Banda gips carton

NUMER KATALOGOWY			
020 188	48 mm	60 m	1/36



TAŚMA ANTYRYSOWA

Anti scratch self adhesive fiberglass tape • Лента ремонтная
• Anti-Rissband • Banda pentru imbinare

NUMER KATALOGOWY			
020 105	50 mm	10 m	1/52



TAŚMA PAPIEROWA

Plasterboard paper joint tape • Лента углоформирующая бумаж.
• Fugendeckstreifen mit Perforation • Banda hartie pentru finisare

NUMER KATALOGOWY			
020 195	50 mm	75 m	1/24



TAŚMA Z WKŁADKĄ METALOWĄ

Metal corner tape • Лента с метал. вкладкой • Metall Kantenschutz
• Banda pentru protectia colturilor

NUMER KATALOGOWY			
020 220	50 mm	30 m	1/10



TAŚMA Z WKŁADKĄ ALUMINIOWĄ

Aluminum corner tape • Лента с алюм. вкладкой • Alu Kantenschutz
• Banda aluminiu pentru protectia colturilor

NUMER KATALOGOWY			
020 221	50 mm	30 m	1/10



TAŚMA SIME ŁĄCZENIOWA Q

Drywall joint tape Q • Лента самокл. Q • Съединителна лента Q
• Lipni juosta Q • Armierungsband Sime Q

NUMER KATALOGOWY			
020 317	50 mm	12 m	1/12
020 318	50 mm	25 m	1/18



TAŚMA SIME NAROŻNIKOWA V

Drywall corner tape V • Лента самокл. V • Съединителна лента V
• Lipni juosta V • Armierungsband Sime V

NUMER KATALOGOWY			
020 319	50 mm	12 m	1/12
020 320	50 mm	25 m	1/18





TAŚMA AKUSTYCZNA

Foam adhesive tape • Лента акустическая, клейкая • Trennwandband
• Banda adeziva pentru etansare

NUMER KATALOGOWY			
020 100	30 mm	30 m	1/32
020 101	50 mm	30 m	1/18
020 102	70 mm	30 m	1/14
020 103	95 mm	30 m	1/10



TAŚMA MONTAŻOWA

Outdoor mounting tape • Скотч 2-х.стор. на вспененной основе
• Doppelseitiges Montageband • Banda dublu adeziva pentru fixare

NUMER KATALOGOWY				
020 175	czarna/black	12 mm	5 m	1/20
020 176	czarna/black	19 mm	5 m	1/20



TAŚMA MONTAŻOWA

Indoor mounting tape • Скотч 2-х.стор. на вспененной основе
• Doppelseitiges Montageband • Banda dublu adeziva pentru fixare

NUMER KATALOGOWY				
020 177	biała/white	12 mm	5 m	1/20
020 178	biała/white	19 mm	5 m	1/20

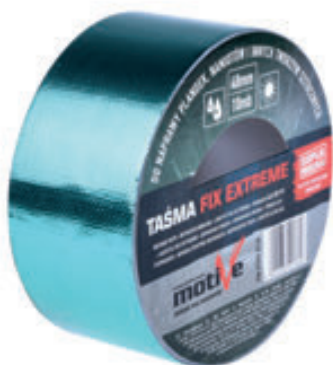

TAŚMA FIX EXTREME

Repair tape • Лента ремонтная "FIX EXTREME" • Reparaturklebeband für Gewebeplanen • Banda adeziva, pentru reparatii Fix Extreme

NUMER KATALOGOWY			
020 216	48 mm	10 m	1/36



TAŚMA POWER FIX

Power Fix tape • Лента ремонтная "POWER FIX" • Doppelseitiges Montageklebeband • Banda dublu adeziva pentru fixare

NUMER KATALOGOWY			
020 174	19 mm	1,5 m	1/32



TAŚMA IZOLACYJNA

Insulating tape • Изолента чёрная • Isolierband-schwarz
• Banda izolatoare neagra

NUMER KATALOGOWY			
020 136	19 mm	10 m	10/300



TAŚMA IZOLACYJNA KOLOR

Insulating tape • Изолента цветная • Isolierband- bunt • Banda izolatoare

NUMER KATALOGOWY			
020 135	15 mm	10 m	10/300



TAŚMA USZCZELNIAJĄCA PTFE

Sealing up teflon tape/PTFE thread seal tape • Лента герметизирующая тефлоновая • PTFE Band • Banda PTFE

NUMER KATALOGOWY				
020 173	x10	12 mm	10 m	10/1000



TAŚMA DO OTULIN

Duct tape • Лента универсальная • Reparaturband • Banda adeziva duct

NUMER KATALOGOWY				
020 260		48 mm	50 m	1/24
020 261		48 mm	50 m	1/24



TAŚMA METALIZOWANA

Metalized tape • Лента клейкая металлизированная • Alu- PP Klebeband
• Bandă adezivă de aluminiu

NUMER KATALOGOWY			
020 170	50 mm	50 m	1/96





motive
Jakość ma znaczenie

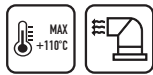

TAŚMA ALUMINIOWA 110°C

Aluminium tape • Лента алюминиевая • Aluminiumband
• Banda adeziva, pentru reparatii, din aluminiu

NUMER KATALOGOWY			
020 106	48 mm	45 m	1/24
020 096	48 mm	25 m	1/30



motive
Jakość ma znaczenie

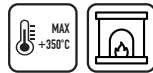

TAŚMA ALUMINIOWA 350°C

Aluminium tape • Лента алюминиевая • Aluminiumband
• Banda adeziva, pentru reparatii, din aluminiu

NUMER KATALOGOWY			
020 104	50 mm	25 m	1/30
020 107	50 mm	50 m	1/24



motive
Jakość ma znaczenie



TAŚMA ANTYPOŚLIZGOWA CZARNA

Anti Slip tape - black • Лента противоскользящая • Anti-Rutsch Klebeband
• Banda adeziva antialunecare

NUMER KATALOGOWY			
020 217	50 mm	5 m	1/24



motive
Jakość ma znaczenie



TAŚMA ANTYPOŚLIZGOWA FLUO

Anti Slip tape - FLUO • Лента противоскользящая с флуоресцентной вставкой • Anti-Rutsch Klebeband • Banda antialunecare fluorescenta

NUMER KATALOGOWY			
020 218	50 mm	5 m	1/24



motive
Jakość ma znaczenie



TAŚMA ANTYPOŚLIZGOWA CLEAR (BEZBARWNA)

Anti Slip tape • Противоскользящая лента • Anti-Rutschband
• Banda adeziva antialunecare

NUMER KATALOGOWY			
020 219	25 mm	5 m	1/48



TAŚMA OSTRZEGAWCZA

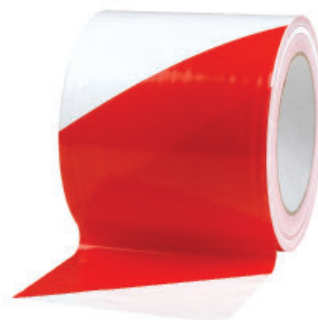

Heavy duty warning tape • Лента сигнальная • Warnband rot/weiß
• Banda delimitare dungii rosu

NUMER KATALOGOWY			
020 189	100 mm	100 m	1/18



TAŚMA OSTRZEGAWCZA

Hazard warning tape • Лента сигнальная • Warnband rot/weiß
• Banda delimitare dungii rosu

NUMER KATALOGOWY			
020 190	75 mm	100 m	1/24
020 193	80 mm	200 m	1/30
020 194	80 mm	500 m	1/16



TAŚMA OSTRZEGAWCZA KLEJĄCA

Hazard warning tape, black/yellow self adhesive • Лента сигнальная жел./черн. клейкая • Warnklebeband schwarz / gelb
• Banda adeziva delimitare negru/galben

NUMER KATALOGOWY			
020 192	48 mm	25 yd	1/24



TAŚMA OSTRZEGAWCZA ŻÓŁTO-CZARNA

Hazard warning tape, black/yellow • Лента сигнальная жел./черн.
• Warnband schwarz/gelb • Banda delimitare dungii negru/galben

NUMER KATALOGOWY			
020 191	80 mm	100 m	1/42



TAŚMA OPAKOWANIOWA BEZBARWNA

Packing tape transparent • Скотч бесцветный • Packband transparent
• Banda adeziva pentru ambalare transparenta

NUMER KATALOGOWY			
020 181	48 mm	40 yd	6/36





TAŚMA OPAKOWANIOWA BIAŁA

Packaging tape white • Скотч белый • Packband weiß
• Banda adeziva pentru ambalare alba

NUMER
KATALOGOWY



020 182

48 mm

40 yd

6/36



TAŚMA OPAKOWANIOWA

Packing tape • Скотч • Packband • Banda adeziva pentru ambalare

NUMER
KATALOGOWY



020 180

48 mm

40 yd

6/36



TAŚMA OPAKOWANIOWA BRĄZOWA

Packing tape brown • Клейкая лента (скотч) • Packband, braun
• Banda adeziva pentru ambalare maro

NUMER
KATALOGOWY



020 185

48 mm

60 yd

6/36



TAŚMA DO KLEJENIA KARTONU

Packing tape • Скотч • Packband • Banda adeziva pentru ambalare

NUMER
KATALOGOWY



020 184

48 mm

60 yd

6/36



TAŚMA OPAKOWANIOWA BEZSZELESTNA

Low noise packing tape • Скотч бесшумный • PP-Packband leise abrollend
• Banda adeziva pentru ambalare

NUMER
KATALOGOWY



020 179

48 mm

66 m

6/36



TAŚMA DO KLEJENIA KARTONU

Packing tape • Скотч • Packband • Banda adeziva PP

NUMER
KATALOGOWY

020 440



96 mm

60 m

1/18



TAŚMA OPAKOWANIOWA Z INDYWIDUALNYM NADRUKIEM

Packing tape with personalized printing logo • Скотч с индивидуальной печатью • Packband mit Logo • Banda pentru ambalare

NUMER
KATALOGOWY

9876



48 mm

60 m

36



DYSPENSER

Tape gun • Диспенсер • Packband Handabroller • Dispenser banda adeziva pentru ambalare

NUMER
KATALOGOWY

020 187



1/24



SIATKA DO DOCIEPLEŃ 145 g/m²

Fiberglass mesh • Строительная сетка для утепления • Armierungsgewebe • Plasă fibra sticla

NUMER
KATALOGOWY

090 180

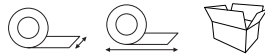

1 m

50 m

50/1500 m²



ARTYKUŁY MALARSKIE

МАЛЯРНЫЕ ИНСТРУМЕНТЫ • PAINTING TOOLS AND ACCESSORIES

• MALERWERKZEUGE • UNELTE DE ZUGRAVIT



JAKI WAŁEK, DO JAKICH FARB?

		DOSTĘPNE DŁUGOŚCI 	DŁUGOŚĆ WŁOSIA 	DO JAKICH POWIERZCHNI GŁADKICH, CHROPOWATYCH, CZY NIERÓWNYCH 			RODZAJ WŁOSIA	NA JAKI UCHWYT 	DO JAKICH FARB I LAKIERÓW
WAŁKI KLASYCZNE									
NYLON FLOOR		18 cm 25 cm	4 mm				NYLON	8 mm	 do farb, lakierów i żywic na bazie agresywnych rozpuszczalników, ale również do farb wodnych
VELUR		18 cm 25 cm	4 mm				VELUR	8 mm	 do farb, lakierów i żywic na bazie agresywnych rozpuszczalników, ale również do farb wodnych
SPRINGFIELD		18 cm 25 cm	9 mm				MICROFIBRA	8 mm	 do farb, emulsji i impregnatów na bazie wody, do farb akrylowych i lateksowych
GREENFIELD		18 cm 25 cm	10 mm				MICROFIBRA	8 mm	 do farb, emulsji i impregnatów na bazie wody, do farb akrylowych i lateksowych
MICROGREEN		18 cm 25 cm	10 mm				ENDLESS	8 mm	 do farb, emulsji i impregnatów na bazie wody, do farb akrylowych i lateksowych
MICROSTAR		18 cm 25 cm 40 cm	10 mm				POLIESTER	8 mm	 do farb, emulsji i impregnatów na bazie wody, do farb akrylowych i lateksowych
SILVERAMID		18 cm 25 cm	12 mm				ENDLESS	8 mm	 do farb, emulsji i impregnatów na bazie wody, do farb akrylowych i lateksowych
GOLDLINE		18 cm 25 cm	12 mm				POLIAMID	8 mm	 do farb, lakierów i żywic na bazie agresywnych rozpuszczalników, ale również do farb wodnych
VOLCANO		18 cm 25 cm	13 mm				POLIAMID	8 mm	 do farb, lakierów i żywic na bazie agresywnych rozpuszczalników, ale również do farb wodnych
NYLON		18 cm 25 cm 40 cm	14 mm				NYLON	8 mm	 do farb, lakierów i żywic na bazie agresywnych rozpuszczalników, ale również do farb wodnych
ARCTIC		18 cm 25 cm	14 mm				NYLON	8 mm	 do farb, lakierów i żywic na bazie agresywnych rozpuszczalników, ale również do farb wodnych
BLUECOLOR		18 cm 25 cm	18 mm				POLIAKRYL	8 mm	 do farb, emulsji i impregnatów na bazie wody, do farb akrylowych i lateksowych
BLUECOLOR FASADOWY		18 cm 25 cm	18 mm				POLIAKRYL	8 mm	 do farb, emulsji i impregnatów na bazie wody, do farb akrylowych i lateksowych
POLIGREEN		18 cm 25 cm	18 mm				POLIAKRYL	8 mm	 do farb, emulsji i impregnatów na bazie wody, do farb akrylowych i lateksowych
VOLCANO MAX		18 cm 25 cm	21 mm				POLIAMID	8 mm	 do farb, lakierów i żywic na bazie agresywnych rozpuszczalników, ale również do farb wodnych
MELANŻ		27 cm	21 mm				POLIAMID	8 mm	 do farb, lakierów i żywic na bazie agresywnych rozpuszczalników, ale również do farb wodnych
MELANŻ PROFI		27 cm	21 mm				POLIAMID	8 mm	 do farb, lakierów i żywic na bazie agresywnych rozpuszczalników, ale również do farb wodnych
WAŁKI KOSZYKOWE									
V-PRO FIBRA		10 cm 23 cm	10 mm				MICROFIBRA	19 mm 38 mm	 do farb, emulsji i impregnatów na bazie wody, do farb akrylowych i lateksowych
V-PRO NYLON		10 cm 23 cm	11 mm				NYLON	19 mm 38 mm	 do farb, lakierów i żywic na bazie agresywnych rozpuszczalników, ale również do farb wodnych
V-PRO PES		10 cm 23 cm	12 mm				POLIESTER	19 mm 38 mm	 do farb, emulsji i impregnatów na bazie wody, do farb akrylowych i lateksowych

SZEROKOŚCI W MALOWANIU!

SZEROKI UCHWYT DO WAŁKÓW. Dedykowany dla tych, którzy malują duże powierzchnie. Dzięki niemu oraz szerokiemu wałkowi pomalowane metry kwadratowe pojawiają się jeden za drugim. Regulowane ramiona pozwalają zamocować wałki o szerokości nawet do 50 cm. Ergonomiczna i wygodna rękojeść wyposażona jest w gwint współpracujący z większością kijów teleskopowych.

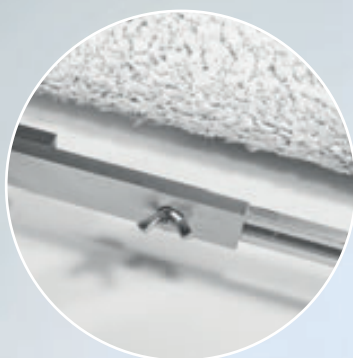
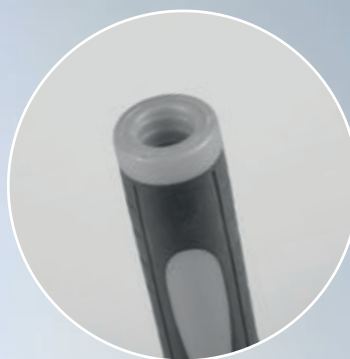
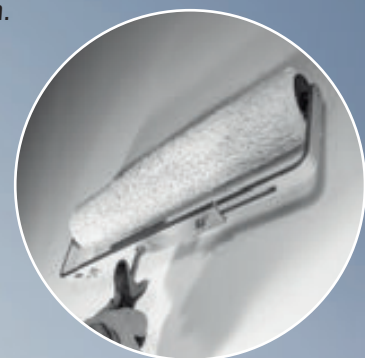
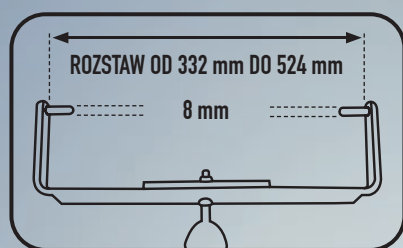

Regulacja rozstawu i szybka blokada przy pomocy dwóch śrub motylkowych

Ergonomiczny uchwyt z gwintem do kijów teleskopowych

Sztywny anodowany na srebro profil aluminiowy

nr kat. 030 413



DUŻA

motive
Jakość ma znaczenie

KUWETA MALARSKA

DUŻA KUWETA MALARSKA TO NOWY PRODUKT OD

MOTIVE, który powstał z myślą o fachowcach zawodowo zajmujących się malowaniem dużych powierzchni. Gabaryty oraz pojemność kuwety pozwalają na wykorzystanie jej w pracy z szerokimi wałkami, których głównie używa się do malowania wielkich powierzchni, gdzie liczy się ilość pomalowanych metrów w krótkim czasie. Kuweta wykonana jest z odpornego tworzywa. Wykorzystasz ją zatem nie tylko do farb wodnych, ale również do lakierów i żywic. Kuweta z powodzeniem posłużyć może również jako miska warsztatowa do mycia elementów i części mechanicznych, a w sytuacjach awaryjnych do kuwety możesz nasypać żwirku dla kota i też zadziała. 😊

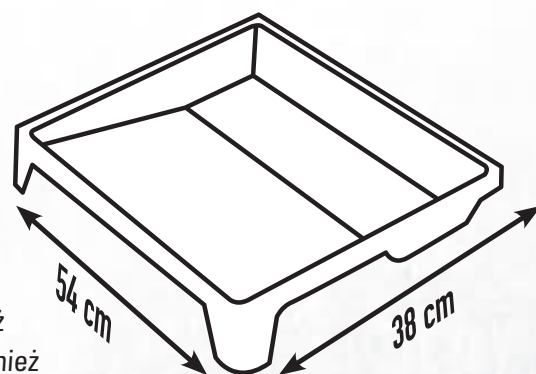

W OFERCIE ZNAJDZIESZ RÓWNIEŻ WKŁADY DO KUWETY

DZIĘKI NIM SZYBKO ZMIENISZ KOLOR BEZ KONIECZNOŚCI MYCIA KUWETY



Głębokie dno kuwety pozwala na rzadsze dolewanie farby

Wzmocnione, wyprofilowane ranty

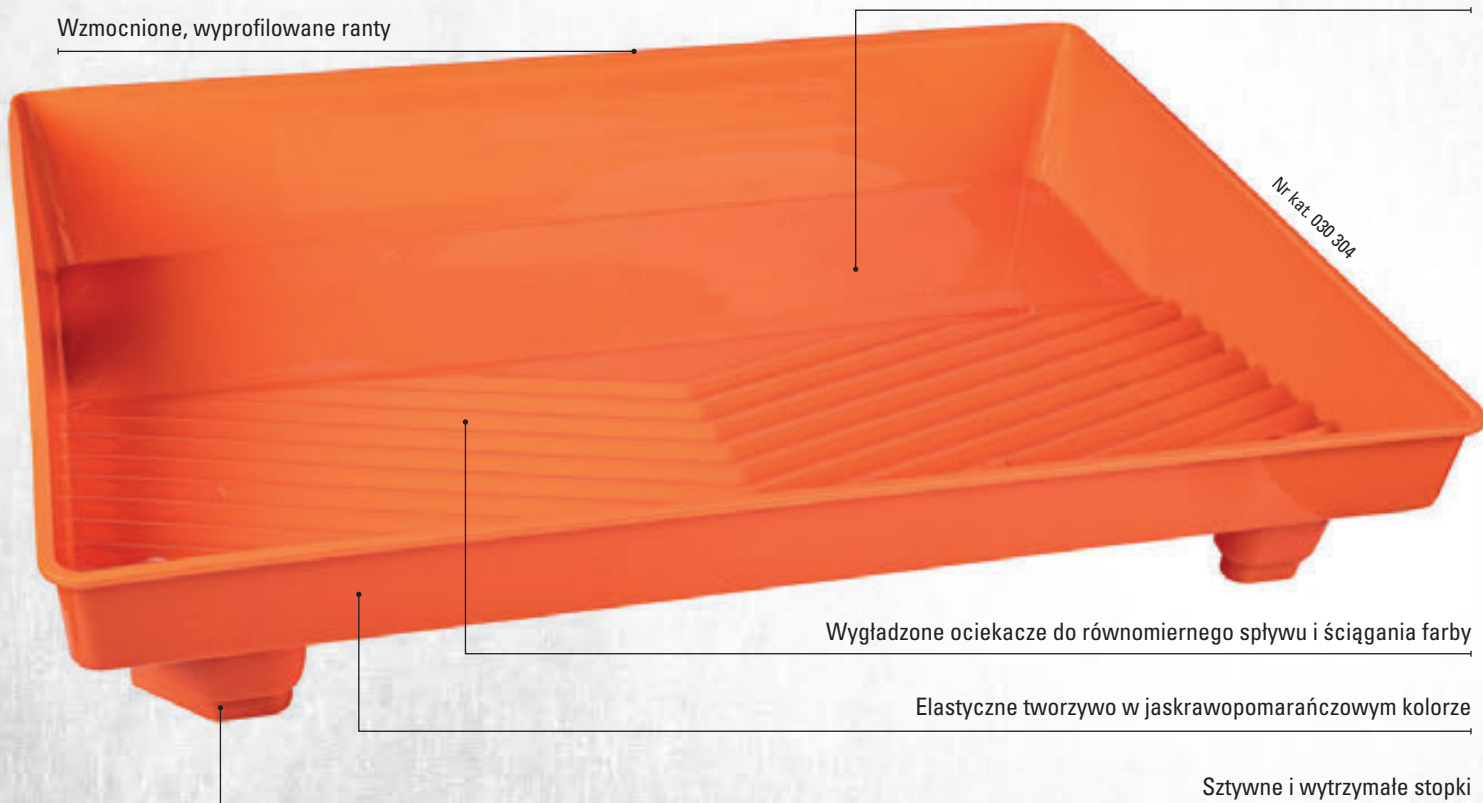

Wygładzone ociekacze do równomiernego spływu i ściągania farby

Elastyczne tworzywo w jaskrawopomarańczowym kolorze

Sztuczne i wytrzymałe stopki

motive
Jakość ma znaczenie



WKŁAD VOLCANO (2 SZT.)

2 x VOLCANO roller refill • 2 x Минивалик "VOLCANO"
• 2 x Kleinflächenwalze Volcano • 2 x Rola poliamida Volcano

NUMER KATALOGOWY					
030 701	10 cm	18 mm	13 mm	6 mm	1/500

motive
Jakość ma znaczenie

POLYAMIDE



WAŁEK VOLCANO

VOLCANO roller refill • Валик "VOLCANO" запас • Malerwalze Volcano
• Rola poliamida Volcano

NUMER KATALOGOWY					
030 600	18 cm	48 mm	13 mm	8 mm	1/75
030 601	25 cm	48 mm	13 mm	8 mm	1/50

motive
Jakość ma znaczenie

POLYAMIDE



WAŁEK VOLCANO MAX

VOLCANO MAX roller refill • Валик "VOLCANO MAX" запас • Fassaden-Malerwalze Volcano Max • Rola de fatada poliamida Volcano MAX

NUMER KATALOGOWY					
030 602	18 cm	48 mm	21 mm	8 mm	1/75
030 603	25 cm	48 mm	21 mm	8 mm	1/50

motive
Jakość ma znaczenie

POLYAMIDE



WKŁAD SPRINGFIELD (2 SZT.)

2 x SPRINGFIELD roller refill • 2 x Минивалик "SPRINGFIELD"
• 2 x Kleinflächenwalze Springfield • 2 x Rola Springfield

NUMER KATALOGOWY					
030 705	10 cm	18 mm	9 mm	6 mm	1/500

motive
Jakość ma znaczenie

MICROFIBRE



WAŁEK SPRINGFIELD

SPRINGFIELD roller refill • Валик "SPRINGFIELD" запас • Malerwalze Springfield
• Rola Springfield

NUMER KATALOGOWY					
030 610	18 cm	48 mm	9 mm	8 mm	1/75
030 611	25 cm	48 mm	9 mm	8 mm	1/50

motive
Jakość ma znaczenie

MICROFIBRE





WKŁAD SILVERAMID (2 SZT.)

2 x SILVERAMID roller refill • 2 x Минивалик "SILVERAMID"
• 2 x Kleinflächenwalze Silveramid • 2 x Rola Silveramid

NUMER KATALOGOWY					
030 715	10 cm	18 mm	12 mm	6 mm	1/500



WAŁEK SILVERAMID

SILVERAMID roller refill • Валик "SILVERAMID" запас • Malerwalze Silveramid
• Rola Silveramid

NUMER KATALOGOWY					
030 614	18 cm	48 mm	12 mm	8 mm	1/75
030 615	25 cm	48 mm	12 mm	8 mm	1/50



WAŁEK BLUECOLOR

BLUECOLOR roller refill • Валик "BLUECOLOR" запас • Malerwalze Bluecolor
• Rola Bluecolor

NUMER KATALOGOWY					
030 232	18 cm	48 mm	18 mm	8 mm	1/75
030 233	25 cm	48 mm	18 mm	8 mm	1/50



WAŁEK BLUECOLOR FASADOWY

BLUECOLOR roller refill + foam • Ролка "BLUECOLOR" фасад
• Fassaden-Malerwalze Bluecolor • Rola de fatada Bluecolor

NUMER KATALOGOWY						
030 234	18 cm	48 mm	18 mm	4 mm	8 mm	1/50
030 235	25 cm	48 mm	18 mm	4 mm	8 mm	1/50



WKŁAD POLIGREEN (2 SZT.)

2 x POLIGREEN roller refill • 2 x Минивалик "POLIGREEN"
• 2 x Kleinflächenwalze Poligreen • 2 x Rola Poligreen

NUMER KATALOGOWY					
030 292	10 cm	18 mm	12 mm	6 mm	1/100



WAŁEK POLIGREEN

POLIGREEN roller refill • Валик фасадный "POLIGREEN" запас
• Malerwalze Poligreen • Rola Poligreen

NUMER KATALOGOWY					
030 286	18 cm	48 mm	18 mm	8 mm	1/10
030 287	25 cm	48 mm	18 mm	8 mm	1/10

WKŁAD ARCTIC (2 SZT.)

2 x ARCTIC roller refill • 2 x Минивалик "ARCTIC" • 2 x Kleinflächenwalze Arctic
• 2 x Rola Arctic

NUMER KATALOGOWY					
030 718	10 cm	18 mm	18 mm	6 mm	1/500

WAŁEK ARCTIC

ARCTIC roller refill • Валик "ARCTIC" запас • Malerwalze Arctic • Rola Arctic

NUMER KATALOGOWY					
030 606	18 cm	48 mm	14 mm	8 mm	1/75
030 607	25 cm	48 mm	14 mm	8 mm	1/50

WAŁEK GREENFIELD

GREENFIELD roller refill • Валик "GREENFIELD" запас • Malerwalze Greenfield
• Rola Greenfield

NUMER KATALOGOWY					
030 604	18 cm	48 mm	10 mm	8 mm	1/75
030 605	25 cm	48 mm	10 mm	8 mm	1/50

WKŁAD MICROGREEN (2 SZT.)

2 x MICROGREEN roller refill • 2 x Минивалик "MICROGREEN"
• 2 x Kleinflächenwalze Microgreen • 2 x Rola Microgreen

NUMER KATALOGOWY					
030 291	10 cm	18 mm	10 mm	6 mm	1/300

motiVe
Jakość ma znaczenie

POLYACRYL

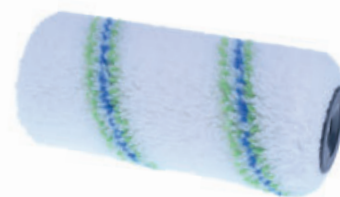

motiVe
Jakość ma znaczenie

NYLON PESH MIX

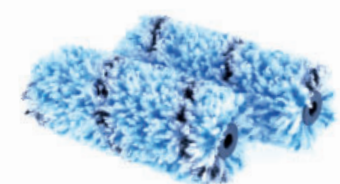

motiVe
Jakość ma znaczenie

NYLON PESH MIX



motiVe
Jakość ma znaczenie

MICROFIBRE



motiVe
Jakość ma znaczenie

POLYAMIDE ENDLESS



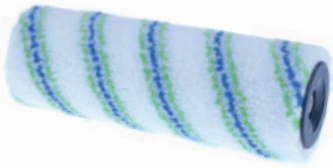

motive
Jakość ma znaczenie

**POLYAMIDE
ENDLESS**



WAŁEK MICROGREEN

MICROGREEN roller refill • Валик "MICROGREEN" запас
• Malerwalze Microgreen • Rola Microgreen

NUMER KATALOGOWY					
030 284	18 cm	48 mm	10 mm	8 mm	1/10
030 285	25 cm	48 mm	10 mm	8 mm	1/10



motive

POLYESTER



WKŁAD MICROSTAR (2 SZT.)

2 x Mini MICROSTAR roller refill • 2 x Минивалик "MICROSTAR"
• 2 x Kleinflächenwalze Microstar • 2 x Rola Microstar

NUMER KATALOGOWY					
030 290	7 cm	17 mm	10 mm	6 mm	1/300
030 263	10 cm	17 mm	10 mm	6 mm	1/300
030 264	15 cm	17 mm	10 mm	6 mm	1/250



motive

POLYESTER



WKŁAD MICROSTAR MIDI (2 SZT.)

2 x Midi MICROSTAR roller refill • 2 x Минивалик "MICROSTAR MIDI"
• 2 x Kleinflächenwalze Microstar midi • 2 x Rola Microstar Midi

NUMER KATALOGOWY					
030 272	10 cm	30 mm	10 mm	6 mm	1/200
030 273	15 cm	30 mm	10 mm	6 mm	1/200



motive

POLYESTER



WAŁEK MICROSTAR

MICROSTAR roller refill • Валик "MICROSTAR" запас • Malerwalze Mirostar
• Rola Microstar

NUMER KATALOGOWY					
030 240	18 cm	48 mm	10 mm	8 mm	1/50
030 241	25 cm	48 mm	10 mm	8 mm	1/50



motive
Jakość ma znaczenie

POLYESTER



WAŁEK MICROSTAR

MICROSTAR roller refill • Валик "MICROSTAR" запас • Malerwalze Mirostar
• Rola Microstar

NUMER KATALOGOWY					
030 612	40 cm	48 mm	10 mm	8 mm	1/50





WAŁEK GOLDLINE

GOLDLINE roller refill • Валик "GOLDLINE" запас • Malerwalze Goldfaden
• Rola Goldline

NUMER KATALOGOWY					
030 247	18 cm	48 mm	12 mm	8 mm	1/50
030 248	25 cm	48 mm	12 mm	8 mm	1/50

WKŁAD NYLON (2 SZT.)

2 x Mini NYLON roller refill • 2 x Минивалик "NYLON" • 2 x Mini volelis NYLON
• 2 x Kleinflächenwalze Nylon • 2 x Rola Nylon

NUMER KATALOGOWY					
030 260	7 cm	17 mm	14 mm	6 mm	1/500
030 261	10 cm	17 mm	14 mm	6 mm	1/300
030 262	15 cm	17 mm	14 mm	6 mm	1/250

WKŁAD NYLON MIDI (2 SZT.)

2 x Midi NYLON roller refill • 2 x Минивалик "NYLON MIDI"
• 2 x Kleinflächenwalze Midi Nylon • 2 x Rola Nylon Midi

NUMER KATALOGOWY					
030 270	10 cm	30 mm	14 mm	6 mm	1/200
030 271	15 cm	30 mm	14 mm	6 mm	1/200

WAŁEK NYLON

NYLON roller refill • Валик "NYLON" запас • Malerwalze Nylon

NUMER KATALOGOWY					
030 012	18 cm	48 mm	14 mm	8 mm	1/50
030 013	25 cm	48 mm	14 mm	8 mm	1/50

WAŁEK NYLON

NYLON roller refill • Валик "NYLON" запас • Malerwalze Nylon • Rola Nylon

NUMER KATALOGOWY					
030 014	40 cm	48 mm	12 mm	8 mm	1/50

motive



motive
Jakość ma znaczenie



motive
Jakość ma znaczenie



motive
Jakość ma znaczenie



motive
Jakość ma znaczenie





motive
Jakość ma znaczenie

NYLON



WAŁEK NYLON FLOOR

NYLON FLOOR roller refill • Валик "NYLON FLOOR" запас
• Malerwalze Nylon Floor • Rola Nylon Floor

NUMER KATALOGOWY					
030 280	18 cm	48 mm	4 mm	8 mm	1/10
030 281	25 cm	48 mm	4 mm	8 mm	1/10



motive
Jakość ma znaczenie

POLYESTER



WAŁEK POLIAZUR

POLIAZUR roller refill • Валик "POLIAZUR" запас • Malerwalze Poliazur
• Rola Poliazur

NUMER KATALOGOWY					
030 608	18 cm	48 mm	12 mm	8 mm	1/75
030 609	25 cm	48 mm	12 mm	8 mm	1/50



motive
Jakość ma znaczenie

NATURAL



WKŁAD VELUR (2 SZT.)

2 x Mini VELUR roller refill • 2 x Минивалик "VELUR"
• 2 x Kleinflächenwalze Velour • 2 x Rola Velur

NUMER KATALOGOWY					
030 257	7 cm	17 mm	4 mm	6 mm	1/500
030 258	10 cm	17 mm	4 mm	6 mm	1/250
030 259	15 cm	17 mm	4 mm	6 mm	1/250



motive
Jakość ma znaczenie

NATURAL



WKŁAD MIDI VELUR (2 SZT.)

2 x Midi VELUR roller refill • 2 x Минивалик "VELUR MIDI"
• 2 x Kleinflächenwalze Midi Velour • 2 x Rola Velur Midi

NUMER KATALOGOWY					
030 268	10 cm	30 mm	4 mm	6 mm	1/200
030 269	15 cm	30 mm	4 mm	6 mm	1/200



motive
Jakość ma znaczenie

VELUR



WAŁEK VELUR

VELUR roller refill • Валик "VELUR" запас • Ролка VELUR • Volelis VELUR
• Malerwalze Velur • Rola Velur

NUMER KATALOGOWY					
030 236	18 cm	48 mm	4 mm	8 mm	1/50
030 237	25 cm	48 mm	4 mm	8 mm	1/50



- Wysokiej jakości wałki koszykowe do różnych rodzajów farb
- Kompatybilne z uchwytemi koszykowymi V-PRO i Wooster
- Wydajne w użyciu i trwale w eksploatacji



V-PRO

WSPÓŁPRACUJE
Z SYSTEMEM KOSZYKOWYM

WOOSTER®

WAŁEK KOSZYKOWY FIBRA

Cage roller sleeve • Валик для каркасной ручки "FIBRA"
• Malerwalze für Korbbügel • Rola Fibra

NUMER KATALOGOWY					
030 640	10 cm	19 mm	10 mm	10 mm	1/100
030 620	23 cm	38 mm	10 mm	10 mm	1/36



WAŁEK KOSZYKOWY NYLON

Cage roller sleeve • Валик для каркасной ручки "NYLON"
• Malerwalze für Korbbügel • Rola Nylon

NUMER KATALOGOWY					
030 650	10 cm	19 mm	11 mm	11 mm	1/100
030 621	23 cm	38 mm	11 mm	11 mm	1/36



WAŁEK KOSZYKOWY PES

Cage roller sleeve • Валик для каркасной ручки "PES"
• Malerwalze für Korbbügel • Rola PES

NUMER KATALOGOWY					
030 660	10 cm	19 mm	12 mm	12 mm	1/100
030 622	23 cm	38 mm	12 mm	12 mm	1/36



WAŁEK KOSZYKOWY
**V-PRO
FIBRA**



WAŁEK KOSZYKOWY
**V-PRO
NYLON**



WAŁEK KOSZYKOWY
**V-PRO
PES**

UCHWYT DO WAŁKÓW KOSZYKOWYCH ZNAJDZIESZ NA STR. 79 (nr kat. 030 389, 030 390, 030 409)

WKŁAD GIRPAINT (2 SZT.)

2 x Mini GIRPAINT roller refill • 2 x Минивалик "GIRPAINT" • 2 x Ролка GIRPAINT
• 2 x Kleinflächenwalze Girpaint • 2 x Rola Girpaint

NUMER KATALOGOWY						
030 101	7 cm	15 mm	11 mm	6 mm	1/5/250	
030 102	10 cm	15 mm	11 mm	6 mm	1/5/250	
030 103	15 cm	15 mm	11 mm	6 mm	1/5/250	



WKŁAD MIDI GIRPAINT (2 SZT.)

2 x Midi GIRPAINT roller refill • 2 x Минивалик "MIDI GIRPAINT"
• 2 x Kleinflächenwalze Midi Girpaint • 2 x Rola Girpaint Midi

NUMER KATALOGOWY						
030 131	10 cm	30 mm	11 mm	6 mm	5/250	
030 132	15 cm	30 mm	11 mm	6 mm	5/250	





POLYACRYL



WAŁEK GIRPAINT

GIRPAINT roller refill • Валик "GIRPAINT" запас
• Malerwalze Girpaint • Rola Girpaint

NUMER KATALOGOWY					
030 010	18 cm	48 mm	11 mm	8 mm	70/1400
030 011	25 cm	48 mm	11 mm	8 mm	70/1050



POLYACRYL



ROLKA GIRPAINT

GIRPAINT roller complete with frame • Валик "GIRPAINT" + ручка
• Farbroller Girpaint • Rola Girpaint

NUMER KATALOGOWY					
030 170	18 cm	48 mm	11 mm	8 mm	1/60
030 171	25 cm	48 mm	11 mm	8 mm	1/60



POLYACRYL



WKŁAD MULTIKOLOR (2 SZT.)

2 x MULTIKOLOR roller refill • 2 x Минивалик "MULTIKOLOR"
• 2 x Kleinflächenwalze Multikolor • 2 x Rola Multikolor

NUMER KATALOGOWY					
030 265	7 cm	15 mm	11 mm	6 mm	5/250
030 266	10 cm	15 mm	11 mm	6 mm	5/250
030 267	15 cm	15 mm	11 mm	6 mm	5/250



POLYACRYL



WKŁAD MIDI MULTIKOLOR (2 SZT.)

2 x Midi MULTIKOLOR roller refill • 2 x Минивалик "MIDI MULTIKOLOR"
• 2 x Kleinflächenwalze Midi Multikolor • 2 x Rola Multikolor Midi

NUMER KATALOGOWY					
030 133	10 cm	30 mm	11 mm	6 mm	5/250
030 134	15 cm	30 mm	11 mm	6 mm	5/250



POLYACRYL



WAŁEK MULTIKOLOR

MULTIKOLOR roller refill • Валик "MULTICOLOR" запас • Malerwalze Multikolor
• Rola Multikolor

NUMER KATALOGOWY					
030 027	18 cm	48 mm	16 mm	8 mm	70/1400
030 028	25 cm	48 mm	16 mm	8 mm	70/1050



ROLKA MULTIKOLOR

MULTIKOLOR roller complete with frame • Валик "MULTIKOLOR" + ручка
• Multikolor Roller • Rola Multikolor

NUMER KATALOGOWY						
030 179	18 cm	48 mm	16 mm	8 mm	1/60	
030 180	25 cm	48 mm	16 mm	8 mm	1/30	

WAŁEK MULTIKOLOR FASADOWY

MULTIKOLOR roller refill + foam • Валик фасадный "MULTIKOLOR" запас
• Fassadenwalze Multicolor • Rola de fatada Multikolor

NUMER KATALOGOWY						
030 020	18 cm	48 mm	16 mm	6 mm	8 mm	70/1050
030 021	25 cm	48 mm	16 mm	6 mm	8 mm	70/840

WAŁEK ELITAKOLOR FASADOWY

ELITAKOLOR roller refill + foam • Валик фасадный "ELITAKOLOR" запас
• Fassaden-Malerwalze Elitakolor • Rola de fatada Elitakolor

NUMER KATALOGOWY						
030 018	18 cm	48 mm	16 mm	8 mm	8 mm	70/1050
030 019	25 cm	48 mm	16 mm	8 mm	8 mm	70/840

ROLKA MULTIKOLOR FASADOWY

MULTIKOLOR roller complete with frame + foam • Валик фасадный "MULTIKOLOR" + ручка
• Multikolor Fassadenroller • Rola de fatada Multikolor

NUMER KATALOGOWY						
030 175	18 cm	48 mm	16 mm	6 mm	8 mm	1/30
030 176	25 cm	48 mm	16 mm	6 mm	8 mm	1/30

ROLKA ELITAKOLOR FASADOWY

ELITAKOLOR roller complete with frame + foam • Валик фасадный "ELITAKOLOR" + ручка
• Elitakolor Fassadenroller • Rola de fatada Elitakolor

NUMER KATALOGOWY						
030 173	18 cm	48 mm	16 mm	8 mm	8 mm	1/30
030 174	25 cm	48 mm	16 mm	8 mm	8 mm	1/30

WKŁAD SYNTEX (2 SZT.)

2 x Mini SYNTEX roller refill • 2 x Минивалик "SYNTEX"
• 2 x Kleinflächenwalze Syntex • 2 x Rola Syntex

NUMER KATALOGOWY						
030 128	7 cm	15 mm	11 mm	6 mm	5/250	
030 129	10 cm	15 mm	11 mm	6 mm	5/250	
030 130	15 cm	15 mm	11 mm	6 mm	5/250	

POLYACRYL



POLYACRYL



POLYACRYL

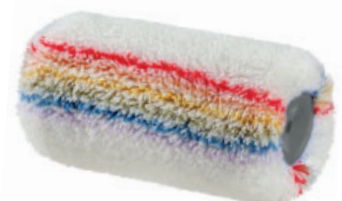

POLYACRYL



POLYACRYL



POLYACRYL





POLYACRYL



WKŁAD MIDI SYNTEX (2 SZT.)

2 x Midi SYNTEX roller refill • 2 x Минивалик "MIDI SYNTEX"
• 2 x Kleinflächenwalze Midi Syntex • 2 x Rola Syntex Midi

NUMER KATALOGOWY					
030 137	10 cm	30 mm	11 mm	6 mm	5/250
030 138	15 cm	30 mm	11 mm	6 mm	5/250



POLYACRYL



WAŁEK SYNTEX

SYNTEX roller refill • Валик "SYNTEX" запас • Malerwalze Syntex • Rola Syntex

NUMER KATALOGOWY					
030 035	18 cm	48 mm	12 mm	8 mm	70/1400
030 036	25 cm	48 mm	12 mm	8 mm	70/1050



POLYACRYL



ROLKA SYNTEX

SYNTEX roller complete with frame • Валик "SYNTEX" + ручка
• Farbroller Syntex • Rola Syntex

NUMER KATALOGOWY					
030 040	18 cm	48 mm	12 mm	6 mm	1/60
030 041	23 cm	48 mm	12 mm	6 mm	1/60



POLYACRYL



WAŁEK SYNTEX FASADOWY

SYNTEX roller refill + foam • Валик фасадный "SYNTEX" запас
• Fassadenwalze Syntex • Rola de fatada Syntex

NUMER KATALOGOWY					
030 037	18 cm	48 mm	16 mm	6 mm	70/1050
030 038	25 cm	48 mm	16 mm	6 mm	70/840



POLYACRYL



ROLKA SYNTEX FASADOWY

SYNTEX roller complete with frame + foam • Валик фасадный "SYNTEX" + ручка
• Syntex Fassadenroller • Rola de fatada Syntex

NUMER KATALOGOWY					
030 183	18 cm	48 mm	16 mm	6 mm	1/30
030 184	25 cm	48 mm	16 mm	6 mm	1/30



WAŁEK ORANGE

ORANGE roller refill • Валик "ORANGE" запас • Malerwalze Orange • Rola Orange

NUMER KATALOGOWY					
030 032	18 cm	48 mm	10 mm	8 mm	1/10/70
030 033	25 cm	48 mm	10 mm	8 mm	1/10/70

ROLKA ORANGE

ORANGE roller complete with frame • Валик "ORANGE" + ручка
• Orange Roller • Rola Orange

NUMER KATALOGOWY					
030 186	18 cm	48 mm	10 mm	8 mm	1/60
030 187	25 cm	48 mm	10 mm	8 mm	1/30

ROLKA WESTAN

WESTAN roller complete with frame • Валик "WESTAN" + ручка
• Vestan Roller • Rola Westan

NUMER KATALOGOWY					
030 227	18 cm	48 mm	15 mm	6 mm	1/60
030 228	23 cm	48 mm	15 mm	6 mm	1/60

ROLKA DULUX

DULUX roller complete with frame • Валик "DULUX" + ручка
• Farbroller Dulux • Rola Dulux

NUMER KATALOGOWY					
030 039	25 cm	58 mm	8 mm	8 mm	1/40

WAŁEK OWCZA WEŁNA

SHEEP WOOL roller refill • Валик "ОВЕЧЬЯ ШЕРСТЬ" запас • Ролка ОВЧА ВЪЛНА
• Volelis "avias kailis" • Malerwalze Lammfell- Synthetik

NUMER KATALOGOWY					
030 030	18 cm	48 mm	16 mm	8 mm	1/10/70
030 031	25 cm	48 mm	16 mm	8 mm	1/10/70

POLYACRYL



POLYACRYL



POLYESTER



POLYESTER





SHEEP WOOL



ROLKA ROLLEX THICK

Rolex roller (sheepskin) • Валик, овечья шерсть "Rolex" + ручка
• Lammfellwalze Rolex • Rola Rollex Thick

NUMER KATALOGOWY					
030 160	18 cm	50 mm	18 mm	7 mm	1/60
030 161	24 cm	50 mm	18 mm	7 mm	1/60



MICROFIBER



WKŁAD MIKROFAZA (2 SZT.)

2 x Mini MIKROFAZA roller refill • 2 x Минивалик "MIKROFAZA"
• 2 x Kleinflächenwalze Microfaser • 2 x Rola Mikrofaza

NUMER KATALOGOWY					
030 141	7 cm	15 mm	10 mm	6 mm	5/250
030 142	10 cm	15 mm	10 mm	6 mm	5/250



MICROFIBER



WAŁEK MIKROFAZA

MIKROFAZA roller refill • Валик "MIKROFAZA" запас • Malerwalze Microfaser
• Rola Mikrofaza

NUMER KATALOGOWY					
030 016	18 cm	48 mm	10 mm	8 mm	1/10/70
030 017	25 cm	48 mm	10 mm	8 mm	1/10/70



MICROFIBER



ROLKA MIKROFAZA

MIKROFAZA roller complete with frame • Валик "MIKROFAZA" + ручка
• Microfaser Roller • Rola Mikrofaza

NUMER KATALOGOWY					
030 190	18 cm	48 mm	10 mm	8 mm	1/60
030 191	25 cm	48 mm	10 mm	8 mm	1/60



WAŁEK DO GŁADZI

Skim coat roller • Гипсовый валик • Spachtel Rolle • Trafalet glet

NUMER KATALOGOWY					
030 195	8 cm	18 mm	8 mm	1/60	
030 197	22 cm	18 mm	8 mm	1/30	



ZAPAS MOLTOFLOK

FLOCK roller refill • Минивалик "MOLTOFLOK" (акрил)
• Flock-Walze • Rola Moltoflok

NUMER KATALOGOWY				
030 530	5 cm	35 mm	6 mm	10/1160
030 531	7 cm	35 mm	6 mm	10/820
030 532	10 cm	35 mm	6 mm	10/560
030 533	15 cm	35 mm	6 mm	10/420



ZAPAS MOLTOFLOK MIDI

FLOCK roller refill MIDI • Минивалик "MOLTOFLOK MIDI" (акрил)
• Flock-Walze Midi • Rola Moltoflok

NUMER KATALOGOWY				
030 535	18 cm	50 mm	6 mm	5/185



ZAPAS MOLTOFLOK (2 SZT.)

2 x FLOCK roller refill • 2 x Минивалик "MOLTOFLOK" (акрил) • 2 x Flock-Walze
• 2 x Rola Moltoflok

NUMER KATALOGOWY				
030 536	5 cm	35 mm	6 mm	1/500
030 537	7 cm	35 mm	6 mm	1/448
030 538	10 cm	35 mm	6 mm	1/320
030 539	15 cm	35 mm	6 mm	1/220



ZAPAS MOLTOFLOK NIEBIESKI (2 SZT.)

2 x Blue flock roller refill • 2 x Минивалик "MOLTOFLOK" (синий)
• 2 x Flock-Walze, blau • Rola Moltoflok albastru

NUMER KATALOGOWY				
030 540	10 cm	35 mm	6 mm	1/320



WKŁAD MIDI NYLON (2 SZT.)

2 x Midi NYLON roller refill • 2 x Минивалик "MIDI NYLON"
• 2 x Kleinflächenwalze Midi Nylon • 2 x Rola Nylon

NUMER KATALOGOWY					
030 135	10 cm	30 mm	9 mm	6 mm	5/250
030 136	15 cm	30 mm	9 mm	6 mm	5/250





NYLON



WAŁEK NYLON (CZERWONY PASEK)

NYLON roller refill (red stripe) • Валик "NYLON" запас (красная полоска)
• Malerwalze Nylon, rot Streifen • Rola Nylon

NUMER KATALOGOWY					
030 025	18 cm	48 mm	12 mm	8 mm	70/1400
030 026	25 cm	48 mm	12 mm	8 mm	70/1050

NYLON



ROLKA NYLON

NYLON roller complete with frame • Валик "NYLON" + ручка
• Nylon Roller • Rola Nylon

NUMER KATALOGOWY					
030 177	18 cm	48 mm	12 mm	8 mm	1/60
030 178	25 cm	48 mm	12 mm	8 mm	1/60



MOLTOPREN

Foam roller refill • Минивалик "MOLTOPREN" • Schaumwalze • Rola Moltopren

NUMER KATALOGOWY				
030 111	5 cm	35 mm	6 mm	10/1600
030 112	7 cm	35 mm	6 mm	10/1100
030 113	10 cm	35 mm	6 mm	10/840
030 114	15 cm	35 mm	6 mm	10/500



MOLTOPREN MIDI

FOAM roller refill • Минивалик "MOLTOPREN" • Schaumwalze Midi
• Rola Moltopren Midi

NUMER KATALOGOWY				
030 115	15 cm	50 mm	6 mm	10/150



MOLTOPREN (2 SZT.)

2 x FOAM roller refill • 2 x Минивалик "MOLTOPREN" • 2 x Schaumwalze
• 2 x Rola Moltopren

NUMER KATALOGOWY				
030 116	5 cm	35 mm	6 mm	1/500
030 117	7 cm	35 mm	6 mm	1/532
030 118	10 cm	35 mm	6 mm	1/380
030 119	15 cm	35 mm	6 mm	1/250



ROLKA MOLTOPREN

Foam roller MOLTOPREN complete with frame • Валик "MOLTOPREN" + ручка
• Schaum Roller • Rola Moltopren

NUMER KATALOGOWY				
030 220	25 cm	80 mm	6 mm	1/50



ROLKA DO SIATKI

Grid roller • Валик для сетки + ручка • Schaum Roller zum Streichen von Gitter
• Trafalet pentru plasă

NUMER KATALOGOWY				
030 052	18 cm	50 mm	6 mm	1/125



WKŁAD VELUR (2 SZT.)

2 x Mini VELUR roller refill • 2 x Минивалик "VELUR"
• 2 x Kleinflächenwalze Velour • 2 x Rola Velur

NUMER KATALOGOWY				
030 125	7 cm	15 mm	4 mm	1/5/250
030 126	10 cm	15 mm	4 mm	1/5/250
030 127	15 cm	15 mm	4 mm	1/5/250



WKŁAD MIDI VELUR (2 SZT.)

2 x Midi VELUR roller refill • 2 x Минивалик "MIDI VELUR"
• 2 x Kleinflächenwalze Midi Velour • 2 x Rola Velur Midi

NUMER KATALOGOWY				
030 139	10 cm	30 mm	4 mm	5/250
030 140	15 cm	30 mm	4 mm	5/250



WAŁEK VELUR

VELUR roller refill • Валик "VELUR" запас • Malerwalze Velur • Rola Velur

NUMER KATALOGOWY				
030 282	18 cm	40 mm	4 mm	1/60/2700
030 283	25 cm	40 mm	4 mm	1/60/2400





VELUR



ROLKA VELUR

VELUR roller complete with frame • Валик "VELUR" + ручка
• Velour Roller • Rola Velur

NUMER KATALOGOWY					
030 215	15 cm	40 mm	4 mm	6 mm	1/60
030 216	25 cm	40 mm	4 mm	6 mm	1/60



KOMPLET MALARSKI

Foam roller set with handle • Комплект малярный • Lackier-Set • Set trafalet

NUMER KATALOGOWY			
030 120	6 cm	30 mm	1/70
030 121	8 cm	30 mm	1/50



KOMPLET MALARSKI NITRO

Flock roller set with handle • Комплект малярный "NITRO"
• Nitro-Set • Set trafalet Nitro

NUMER KATALOGOWY			
030 122	6 cm	30 mm	1/70
030 123	8 cm	30 mm	1/50



WOOSTER®



WKŁAD JUMBOKOTER PRO/DOO-Z FTP (2 SZT.)

2 x PRO/DOO-Z FTP • 2 x Минивалик PRO/DOO-Z FTP
• 2 x Kleinflächenwalze PRO/DOO-Z FTP • Rola PRO/DOO-Z FTP

NUMER KATALOGOWY			
RR 372	4,5" (11,5 cm)	12 mm	1/12



WOOSTER®



WKŁAD PRO/DOO-Z (2 SZT.)



2 x Jumbo-Koter Pro/Doo-Z® • 2 x Минивалик "PRO/DOOZ-Z"
• 2 x Kleinflächenwalze PRO/DOO-Z • Rola PRO/DOO-Z

NUMER KATALOGOWY			
RR302 4 1/2	4,5" (11,5 cm)	9 mm	1/12
RR302 6 1/2	6,5" (16,5 cm)	9 mm	1/6





WAŁEK PRO DOO-Z

Pro Doo-z roller refill • Валик PRO DOO-Z запас • Malerwalze PRO/DOO-Z
• Rola PRO/DOO-Z

NUMER KATALOGOWY			
RR641 9	9" (23 cm)	5 mm	1/12
RR642 9	9" (23 cm)	9 mm	1/12
RR643 9	9" (23 cm)	12 mm	1/12
RR644 9	9" (23 cm)	18 mm	1/12
RR641 18	18" (46 cm)	5 mm	1/6
RR642 18	18" (46 cm)	9 mm	1/6
RR643 18	18" (46 cm)	12 mm	1/6



WAŁEK LAMBSWOOL

LAMBSWOOL roller refill • Валик LAMBSWOOL запас
• Farbwalze Natur-Lammfell • Rola LAMBSWOOL

NUMER KATALOGOWY			
R291 9	9" (23 cm)	12 mm	1/24



WAŁEK SUPER FAB

Super Fab roller refill • Валик Super Fab • Malerwalze SUPER FAB
• Rola SUPER FAB

NUMER KATALOGOWY			
R239 9	9" (23 cm)	9 mm	1/12
R240 9	9" (23 cm)	12 mm	1/12
R241 9	9" (23 cm)	18 mm	1/12
R240 18	18" (46 cm)	12 mm	1/12



WAŁEK AMERICAN CONTRACTOR

American contractor roller refill • Валик American contractor запас
• Farbwalze American contractor • Rola American contractor

NUMER KATALOGOWY			
R363	18" (45,5 cm)	10 mm	1/24

WAŁEK MOHAIR BLEND

MOHAIR BLEND roller refill • Валик MOHAIR BLEND
• Malerwalze MOHAIR BLEND • Rola MOHAIR BLEND

NUMER KATALOGOWY			
R207 9	9" (23 cm)	6 mm	1/12
R207 18	18" (46 cm)	6 mm	1/12

WOOSTER®



5 mm 12 mm 18 mm
9 mm



WOOSTER®



SHEEP WOOL



WOOSTER®



9 mm 12 mm 18 mm



WOOSTER®



WOOSTER®



MOHAIR





WOOSTER®

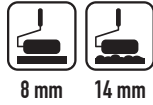

8 mm 14 mm



WAŁEK MICRO PLUSH

MICRO PLUSH roller refill • Валик MICRO PLUSH • Malerwalze MICRO PLUSH
• Rola MICRO PLUSH

NUMER KATALOGOWY			
R235 9	9" (23 cm)	8 mm	1/12
R235 18	18" (46 cm)	8 mm	1/12
R524 18	18" (46 cm)	14 mm	1/12
R524 9	9" (23 cm)	14 mm	1/12

WOOSTER®



WKŁAD MICROFIBRA (2 SZT.)

2 x MICROFIBRA roller refill • 2 x Минивалик MICROFIBRA
• 2 x Kleinflächenwalze Micorfaser • Rola MICROFIBRA

NUMER KATALOGOWY			
RR314 4 1/2	4,5" (11,5 cm)	10 mm	1/12

UCHWYT

Roller frame • Рукоятка-бюгель для миниваликов • Farbrollenbügel
• Maner pentru trafalet

NUMER KATALOGOWY				
030 401	5-7 cm	19 cm	6 mm	1/50
030 402	10-15 cm	27 cm	6 mm	1/50
030 403	10-15 cm	39 cm	6 mm	1/100

UCHWYT

Roller frame • Рукоятка-бюгель для валиков • Farbrollenbügel
• Maner pentru trafalet

NUMER KATALOGOWY				
030 410	18 cm	28 cm	8 mm	1/100/3400
030 411	25 cm	31 cm	8 mm	1/100/3400

UCHWYT DO ZAPASÓW

Roller frame • Рукоятка-бюгель для валиков • Farbrollenbügel
• Maner pentru trafalet

NUMER KATALOGOWY				
030 404	15-18 cm	25,5 cm	6 mm	1/100
030 405	25 cm	28 cm	6 mm	1/100





UCHWYT KOSZYKOWY V-PRO CAGE ROLLER HANDLE

- Wysokiej jakości uniwersalny uchwyt koszykowy do wałków
- Ergonomiczna i wygodna w użyciu rączka
- Gwint na końcu rączki pasujący do większości kijów teleskopowych

motive
Jakość ma znaczenie



motive
Jakość ma znaczenie

ALU



UCHWYT KOSZYKOWY ALUMINIOWY

Cage roller handle • Ручка каркасная • Korbbugel • Maner pentru trafalet

NUMER
KATALOGOWY

030 389



38 mm



23 cm



1/24

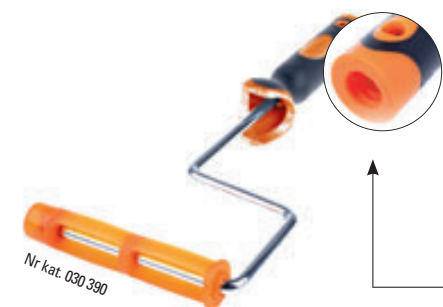

Nr kat. 030 390

gwint mocujący

UCHWYT KOSZYKOWY

Cage roller handle • Ручка каркасная • Korbbugel • Maner pentru trafalet V-Pro

NUMER
KATALOGOWY

030 390



19 mm



10 cm



1/50

030 409

38 mm

23 cm

1/20



Nr kat. 030 409

sprężynowe zapięcie na wałek

łożyskowa konstrukcja uchwytu wykonana z nylonu

WAŁEK KOSZYKOWY
V-PRO
FIBRA

WAŁEK KOSZYKOWY
V-PRO
NYLON

WAŁEK KOSZYKOWY
V-PRO
PES

SPRAWDŹ OFERTĘ
WAŁKÓW KOSZYKOWYCH
(str. 67)





**WSZYSTKIE UCHWYTY SOFT I KOSZYKOWE Z NASZEJ OFERTY
WYPOSAŻONE SĄ W GWINT MOCUJĄCY**

Pasują do kijów teleskopowych z końcówką
z gwintem amerykańskim (patrz: katalog str. 91-92)



motive
Jakość ma znaczenie



UCHWYT SOFT

Soft handle roller frame • Рукоятка-бюгель для валиков "SOFT"
• Farbrollenbügel Soft • Maner pentru trafalet

NUMER KATALOGOWY				
030 408	5-7 cm	19 cm	6 mm	1/50
030 407	10-15 cm	27 cm	6 mm	1/50
030 406	10-15 cm	39 cm	6 mm	1/50

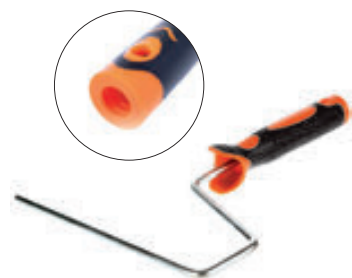

motive
Jakość ma znaczenie



UCHWYT SOFT

Soft handle roller frame • Рукоятка-бюгель для валиков "SOFT"
• Farbrollenbügel Soft • Maner pentru trafalet

NUMER KATALOGOWY				
030 251	18 cm	33 cm	8 mm	1/50
030 252	25 cm	33,5 cm	8 mm	1/50



motive
Jakość ma znaczenie

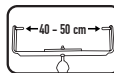

UCHWYT DO WAŁKÓW REGULOWANY

Roller frame • Рукоятка-бюгель для валиков • Rollerbügel für Bodenwalzen
• Maner pentru trafalet

NUMER KATALOGOWY			
030 413	40-50 cm	8 mm	1/30



UCHWYT SHERGRIP

Roller frame Shergrip • Рукоятка Shergrip • Shergrip Korbbugel
 • Maner pentru trafalet Sher Grip

NUMER
KATALOGOWY



R501

9" (23 cm)

1/12

UCHWYT DO WAŁKÓW ACME

Acme™ Heavy-Duty Roller Frame • Рукоятка-бюгель Acme™ Heavy-Duty Roller
 • Roller Korbbugel Acme • Maner pentru trafalet Acme

NUMER
KATALOGOWY



F0010-9

9" (23 cm)

1/24

UCHWYT BIG BEN

Big Ben Roller Frame • Рукоятка-бюгель Big Ben • Farbröllerbugel

NUMER
KATALOGOWY



BR045 18

18" (46 cm)

1/10

UCHWYT DO WAŁKÓW HULK

Sherlock Wide Boy™ Hulk™ • Рукоятка-бюгель Sherlock Wide Boy™ Hulk™
 • Farbröllen Bügel Hulk™ • Maner pentru trafalet Sherlock Wide Boy™ Hulk™

NUMER
KATALOGOWY



BR047-18

12-18" (31-46 cm)

1/3

UCHWYT DO WKŁADÓW

Jumbo-Koter® Frame • Рукоятка-бюгель Jumbo-Koter • Korbbugel für Wooster
 • Maner pentru trafalet Jumbo-Koter

NUMER
KATALOGOWY



RR013

19 mm

12" (31 cm)

1/12

WOOSTER®



WOOSTER®



WOOSTER®



WOOSTER®



WOOSTER®





WOOSTER®



UCHWYT JUMBO - KOTER FLIP FRAME

Jumbo Koter Flip Frame • Ручьятка Jumbo Koter Flip Frame
• Korbbugel Jumbo Koter Flip Frame • Maner pentru trafalet Jumbo Koter Flip Frame

NUMER
KATALOGOWY



RR323

19 mm

4,5" (11,5 cm)

1/12



WOOSTER®



UCHWYT JUMBO KOTER SHERGRIP

Jumbo Koter Shergrip • Ручьятка Jumbo Koter Shergrip • Korbbugel JUMBO-KOTER SHERGRIP • Maner pentru trafalet Jumbo Koter Shergrip

NUMER
KATALOGOWY



RR 028

19 mm

4,5" (11,5 cm)

1/12



WOOSTER®

UCHWYT DO WAŁKÓW SHERLOCK

Sherlock® Roller Frame • Ручьятка-бюгель Sherlock® • Korbbugel Sherlock®
• Maner pentru trafalet Sherlock

NUMER
KATALOGOWY



R017 9

38 mm

9" (23 cm)

1/6



motive
Jakość ma znaczenie

POLYAMIDE

ROLKA DO NAROŻNIKÓW

Corner roller • Валик для покраски углов + ручка • Eckenroller
• Trafalet pentru colt

NUMER
KATALOGOWY



030 211

5 cm

15 mm

6 mm

1/10



POLYACRYL

ROLKA DO NAROŻNIKÓW

Corner roller • Валик для покраски углов + ручка • Eckenroller
• Trafalet pentru colt

NUMER
KATALOGOWY



030 210

5 cm

50 mm

6 mm

1/100



ROLKA DO PASKÓW

Edging paint roller • Валик для полос + ручка • Beschneiderroller
• Trafalet cu distantier

NUMER
KATALOGOWY

030 213



10 mm



10 cm



1/10

ZAPAS DO ROLKI DO PASKÓW

Motive roller refill • Валик для полос запас • Ersatzwalze für Wandkantenroller
• Rezerva pentru trafalet cu distantier

NUMER
KATALOGOWY

030 214



10 mm



10 cm



1/10

OSŁONA ROLKI DO PASKÓW

Cover plate for Motive roller • Защитный элемент для валика для полос
• Abdeckplatte für Wandkantenroller • Capac pentru trafalet cu distantier

NUMER
KATALOGOWY

030 219



1/10

ROLKA DO PASKÓW

• Edging paint roller • Валик для полос + ручка • Beschneiderroller
• Trafalet cu distantier

NUMER
KATALOGOWY

030 222



10 mm



10 cm



1/20

ZAPAS DO ROLKI DO PASKÓW

Roller refill • Валик для полос запас • Ersatzwalze für Wandkantenroller
• Rezerva pentru trafalet cu distantier

NUMER
KATALOGOWY

030 223



10 mm



10 cm



1/200

motive
Jakość ma znaczenie

POLYAMIDE



motive
Jakość ma znaczenie

POLYAMIDE



motive
Jakość ma znaczenie



MICROFIBER



MICROFIBER



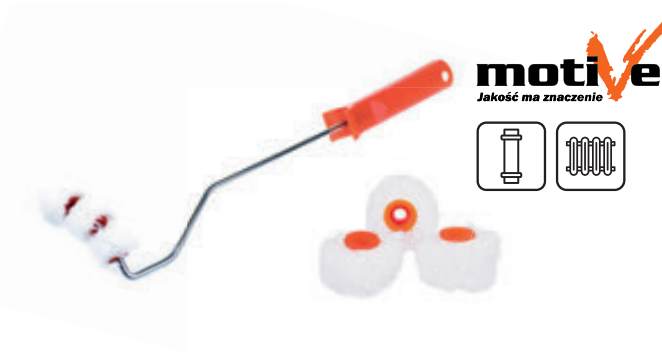

motive
Jakość ma znaczenie

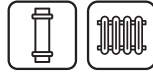

ROLKA DO RUR

Tubes painting roller • Валик для покраски труб + ручка • Rohrroller
• Trafalet pentru tevi

NUMER KATALOGOWY				
030 212	3 x 20 mm	12 mm	6 mm	1/10

ZAPAS DO ROLKI DO RUR - 3 SZT.

Tubes roller refill • Ersatzwalzen für Rohrroller

030 209	3 x 20 mm	12 mm	6 mm	1/500
---------	-----------	-------	------	-------



ROLKA DO STRUKTUR GROSZEK

Structure sponge roller, pea hole • Валик структурный "горошек" + ручка
• Strukturroller, Erbsloch • Trafalet burete poros cu gauri

NUMER KATALOGOWY				
030 202	18 cm	80 mm	6 mm	1/75
030 206	25 cm	80 mm	6 mm	1/50



ROLKA DO STRUKTUR SZORSTKA

Structure sponge roller, coarse • Валик структурный "шероховатый" + ручка
• Strukturroller Schaum • Trafalet burete poros

NUMER KATALOGOWY				
030 201	18 cm	80 mm	6 mm	1/75
030 205	25 cm	80 mm	6 mm	1/50



POLYACRYL

ZESTAW MALARSKI DO EMULSJI NR 30

Painting set for emulsion paints item no. 30 • Набор малярный для эмульсий № 30 • Emulsion-Set Nr 30 • Set trafalet 30

NUMER KATALOGOWY				
030 430	10 cm	27 cm	16 x 28 cm	1/10



POLYACRYL

ZESTAW MALARSKI DO EMULSJI NR 31





Painting set for emulsion paints item no. 31 • Набор малярный для эмульсий № 31 • Emulsion-Set Nr 31 • Set trafalet 31

NUMER KATALOGOWY					
030 431	10 cm	27 cm	1,5"	16 x 28 cm	1/10



ZESTAW MALARSKI DO BEJC NR 15





Painting set for wood stains item no. 15 • Набор малярный для морилок № 15
 • Beize - Set Nr 15 • Set trafalet 15

NUMER KATALOGOWY					
030 415	10 cm	27 cm	1,5"	16 x 28 cm	1/10



ZESTAW MALARSKI DO LAKIERÓW NR 16





Painting set for varnishes item no. 16 • Набор малярный для лаков № 16
 • Lacke - Set Nr 16 • Set trafalet 16

NUMER KATALOGOWY					
030 416	10 cm	27 cm	1,5"	16 x 28 cm	1/10



ZESTAW MALARSKI DO FARB FTALOWYCH NR 7





Painting set for solvent-based paints item no. 7 • Набор малярный для алкидных красок № 7 • Lackier-Set Nr 7 • Set trafalet 7

NUMER KATALOGOWY					
030 107	10 cm	27 cm	16 x 28 cm	1/10	



ZESTAW MALARSKI DO FARB FTALOWYCH NR 4





Painting set for solvent-based paints item no. 4 • Набор малярный для алкидных красок № 4 • Alkyd-Set Nr 4 • Set trafalet 4

NUMER KATALOGOWY					
030 104	10 cm	27 cm	1,5"	16 x 28 cm	1/10



ZESTAW MALARSKI DO FARB WODOROZCIEŃCZALNYCH NR 22

Painting set for water-based paints item no. 22 • Набор малярный для красок на водной основе № 22 • Lasuren-Set Nr 22 • Set trafalet 22





NUMER KATALOGOWY					
030 522	10 cm	27 cm	16 x 28 cm	1/10	





ZESTAW MALARSKI DO FARB WODOROZCIEŃCZALNYCH NR 23





Painting set for water-based paints item no. 23 • Набор малярный для красок на водной основе № 23 • Lasuren-Set Nr 23 • Set trafalet 23

NUMER KATALOGOWY					
030 523	10 cm	27 cm	1,5"	16 x 28 cm	1/10



ZESTAW MALARSKI DO FARB WODOROZCIEŃCZALNYCH NR 24





Painting set for water-based paints item no. 24 • Набор малярный для красок на водной основе № 24 • Lasuren-Set Nr 24 • Set trafalet 24

NUMER KATALOGOWY					
030 524	10 cm	27 cm	1,5"	16 x 28 cm	1/10



ZESTAW MALARSKI DO FARB WODOROZCIEŃCZALNYCH NR 25





Painting set for water-based paints item no. 25 • Набор малярный для красок на водной основе № 25 • Lasuren-Set Nr 25 • Set trafalet 25

NUMER KATALOGOWY				
030 525	10 cm	27 cm	16 x 28 cm	1/10



ZESTAW MOLTOFLOK Z KUWETĄ





Flock roller set with paint tray • Комплект "MOLTOFLOK" + кювета • Lasuren-Set, Flock-Walze in Wanne • Set trafalet Moltoflok cu tava

NUMER KATALOGOWY				
030 520	5 cm	PP	12 x 20 cm	1/50
030 521	7 cm	PP	12 x 20 cm	1/50



ZESTAW MOLTOPREN Z KUWETĄ

Foam roller set with paint tray • Комплект "MOLTOPREN" + кювета • Lackier-Set, Schaumroller in Wanne • Set trafalet Moltopren cu tava

NUMER KATALOGOWY				
030 105	5 cm	PP	12 x 20 cm	1/50
030 106	7 cm	PP	12 x 20 cm	1/50



ZESTAW MOLTOPREN Z KUWETĄ

Foam roller set with paint tray • Комплект "MOLTOPREN" + кювета
• Lackier-Set, Schaumroller in Wanne • Set trafalet Moltopren cu tava

NUMER KATALOGOWY				
030 108	5 cm	19 cm Ø 6 mm	12 x 20 cm	1/50
030 109	7 cm	19 cm Ø 6 mm	12 x 20 cm	1/50
030 110	15 cm	24 cm Ø 6 mm	12 x 20 cm	1/50

ZESTAW MOLTOFLOK Z KUWETĄ

Foam roller set with paint tray • Комплект "MOLTOFLOK" + кювета
• Lackier-Set, Schaumroller in Wanne • Set trafalet Moltoflok cu tava

NUMER KATALOGOWY				
030 541	5 cm	PP	12 x 20 cm	1/50
030 542	7 cm	PP	12 x 20 cm	1/50

ZESTAW MALARSKI MULTIKOLOR

Painting set • Набор малярный • Maler Set • Set trafalet

NUMER KATALOGOWY				
030 432	25 cm	25 cm Ø 6 mm	32 x 34 cm	1/10

ZESTAW MALARSKI SYNTAX

Painting set • Набор малярный • Maler Set • Set trafalet

NUMER KATALOGOWY				
030 433	25 cm	25 cm Ø 6 mm	32 x 34 cm	1/10

ZESTAW MIKROFAZA NR 3

Painting set • Набор малярный • Maler Set • Set trafalet

NUMER KATALOGOWY				
030 438	18 cm	18 cm Ø 8 mm	24 x 26 cm	1/10
030 437	25 cm	25 cm Ø 8 mm	32 x 34 cm	1



POLYACRYL



POLYACRYL



MICROFIBER









POLYACRYL

ZESTAW MALARSKI GIRPAINT

Painting set • Набор малярный • Maler Set • Set trafalet





NUMER KATALOGOWY				
030 434	18 cm	18 cm Ø 8 mm	24 x 26 cm	1/15
030 435	25 cm	25 cm Ø 8 mm	32 x 34 cm	1/10



POLYESTER

ROLKA WESTAN 18 CM Z KUWETA





WESTAN roller set with paint tray • Валик "WESTAN" + ручка + кювета
• Westan Roller mit Farbewanne Set trafalet Westan cu tava

NUMER KATALOGOWY				
030 225	18 cm	18 cm Ø 6 mm	24 x 26 cm	1/20



ROLKA WESTAN Z KRATKĄ

WESTAN roller set with paint tray • Валик "WESTAN" с отжимной решеткой + ручка • Vestan Roller mit Abstreifgitter • Set trafalet Westan cu gratar

NUMER KATALOGOWY				
030 230	18 cm	18 cm Ø 6 mm	20 x 24 cm	1/20
030 231	23 cm	23 cm Ø 6 mm	27 x 30 cm	1/20



motive
Jakość ma znaczenie



MΥJKA DO WAŁKÓW

Paint roller's washer • Устройство для мойки малярных валиков
• Reinigungsgerät für Farbrollen • Dispozitiv curatate role

NUMER KATALOGOWY	
030 335	1



EUROMAL

Euromal painting set • ЕВРОМАЛЬ • Anstreich-Set • Set trafalet Euromal

NUMER KATALOGOWY	
030 003	1/10



ZAPAS DO EUROMALU 3 SZT.

Euromal refill pads - 3 pcs set • Запас для ЕВРОМАЛЯ (3 шт.)
• Ersatzpads für Anstreich-Set • Rezerva pentru Euromal

NUMER KATALOGOWY		
030 001		1/10



MIESZADEŁKO DO FARB

Paint stirrer • Мешалка для красок пластик • Farbrührer / Rührstab Kunststoff
• Mixer pentru vopsea



NUMER KATALOGOWY		
040 277	275 mm	1/20/1000

motive
Jakość ma znaczenie



KUWETA

Paint tray • Кювета • Farbwanne • Tava trafalet



NUMER KATALOGOWY		
030 311	16 x 31 cm	1/90
030 312	34 x 38 cm	1/50

motive
Jakość ma znaczenie



KUWETA MALARSKA DUŻA/WKŁADY DO KUWETY

Paint tray • Кювета • Farbwanne • Tava trafalet

NUMER KATALOGOWY			
030 304	kuweta/paint tray	54 x 38 cm	1
030 318	wkłady/paint tray liners	54 x 38 cm	3

motive
Jakość ma znaczenie

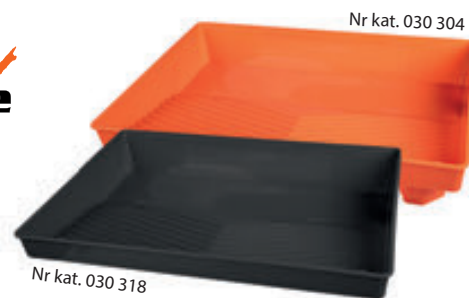

KUWETA MALARSKA

Paint tray • Кювета • Farbwanne • Tava trafalet



NUMER KATALOGOWY			
030 305		12 x 20 cm	1/300
030 306		16 x 28 cm	1/180
030 308		25 x 31 cm	1/50
030 309	BIG	32 x 34 cm	1/50





WKŁAD PLASTIKOWY DO KUWETY

Paint tray liner • Вкладыш в кювету "BIG" • Einlage für Farbwanne Big
• Rezerva din plastic pentru tava trafalet

NUMER KATALOGOWY		
030 300	16 x 28 cm	1/250
030 310	32 x 34 cm	1/100





WOOSTER®



KUWETA BIG BEN

Big Ben™ Tray • Кювета Big Ben • Big Ben Farbwanne

NUMER KATALOGOWY			
BR412-21	3,75 L	21" (54 cm) x 16" (41 cm)	1/6



WOOSTER®



KUWETA MALARSKA

Jumbo-Koter® Tray • Кювета Jumbo-Koter • Farbwanne • Tava trafalet

NUMER KATALOGOWY		
BR403 4 1/2	4 1/2" (11 cm) x 15" (38,5 cm)	1/12





WOOSTER®



KUWETA METALOWA

Deluxe Metal Tray • Кювета Deluxe Metal • Metall Farbwanne

NUMER KATALOGOWY		
R402	11" (28 cm) x 16 1/2" (42 cm)	1/12





WOOSTER®



WKŁAD DO KUWETY



Tray Liners • Вкладыш в кювету • Einlage für Metall Farbwanne

NUMER KATALOGOWY		
R406	11" (28 cm) x 16 1/2" (42 cm)	1/48



KRATKA MALARSKA

Plastic paint grid • Малярная отжимная решетка • Abstreifgitter Kunststoff
 • Gratar plastic

NUMER KATALOGOWY		
030 301	20 x 24 cm	1/150
030 302	27 x 30 cm	1/100



KRATKA MALARSKA METALOWA

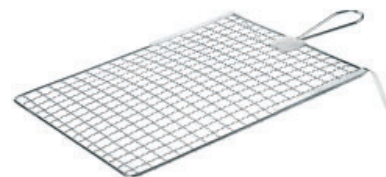

Metal paint grid • Малярная отжимная решетка металл
 • Abstreifgitter • Gratar metalic

NUMER KATALOGOWY		
030 303	26 x 30 cm	1/10/40



KIJ TELESKOPOWY FIBER

Fiberglass extension pole • Ручка телескопическая "FIBER"
 • Maler Teleskopstange • Prelungitor telescopic

NUMER KATALOGOWY		
030 507	0,8-1,4 m	1/10
030 508	1,4-2,4 m	1/10

motive
 Jakość ma znaczenie

ALU



FIBERGLASS

13,5 CM



KIJ TELESKOPOWY ALUMINIOWY

Aluminium extension pole • Ручка телескопическая алюминиевая
 • Maler Teleskopstange • Prelungitor telescopic

NUMER KATALOGOWY		
030 503	1-2 m	1/10
030 504	1,5-3 m	1/10

motive
 Jakość ma znaczenie

ALU



KIJ TELESKOPOWY ALUMINIOWY

Aluminium extension pole • Ручка телескопическая алюминиевая
 • Maler Teleskopstange • Prelungitor telescopic

NUMER KATALOGOWY		
030 505	55-75 cm	1/20

motive
 Jakość ma znaczenie

ALU





KIJ TELESKOPOWY METALOWY

Metal extension pole • Ручка телескопическая • Maler Teleskopstange
• Prelungitor telescopic

NUMER KATALOGOWY	↔	
030 501	1-2 m	1/10
030 502	1,5-3 m	1/10

WOOSTER®

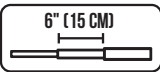

KIJ TELESKOPOWY

Extension Pole Sherlock GT® • Ручка телескопическая "Pole Sherlock GT"
• Teleskopstange • Prelungitor telescopic Sherlock GT®

NUMER KATALOGOWY	↔	
R091	122 - 244 cm	1/6
R092	183 - 366 cm	1/3
R090	61 - 122 cm	1/6

WOOSTER®



ADAPTER DO KIJA TELESKOPOWEGO 2 SZT.

Conversion Tips For Extension Poles 2 pcs • Адаптер к телескопической
ручке 2 шт • Adapter für teleskopstange

NUMER KATALOGOWY	
R042	1/6



WIADRO MALARSKIE

Paint bucket • Малярное ведро • Farbeimer • Galeata vopsea

NUMER KATALOGOWY		
030 314	8 L	1/40
030 315	12 L	1/20



WOOSTER®



WIADRO MALARSKIE MAŁE

4 Gallon Paint bucket • Малярное ведро • Farbeimer

NUMER KATALOGOWY			
8616	34,29 cm x 38,1 cm x 22,86 cm	15,15 L	1/3



POKRYWA MAŁA

4 Gallon Bucket lid • Крышка для ведра • Deckel für 4 Gallon Eimer

NUMER
KATALOGOWY



8626

1/3

WOOSTER®



WIADRO MALARSKIE DUŻE

Wide Boy bucket • Малярное ведро • Бояджийска кофа • Farbeimer

NUMER
KATALOGOWY



8614

35,56 cm x 60,96 cm x 25,4 cm

18,92 L

1/3

WOOSTER®



POKRYWA DUŻA

Wide Boy bucket lid • Крышка для ведра • Deckel für 5 Gallon Eimer

NUMER
KATALOGOWY



8624

1/3

WOOSTER®



SKROBAK ALUMINIOWY

Long, aluminium handle scraper • Скребок для стекол алюминиевый
• Schaber • Răzuitor

NUMER
KATALOGOWY



030 327

10 cm

20 cm

1/6/48

030 328

15 cm

40 cm

1/6/48

motive
Jakość ma znaczenie



OSTRZA SKROBAKA ALUMINIOWEGO (5 SZT.)

Blades for long handle scraper • Лезвия для скребка для стекол алюминиевого
• Ersatzklingen für Schaber • Lame pentru răzuitor

NUMER
KATALOGOWY



030 329

10 cm

1/12/144

030 330

15 cm

1/12/144

motive
Jakość ma znaczenie





motive
Jakość ma znaczenie



SKROBAK DO SZYB

Window scraper • Скребок для стекол (цикля) • Glasschaber • Răzuitor geam

NUMER
KATALOGOWY



030 321

4 cm

1/12/144



motive
Jakość ma znaczenie



OSTRZA SKROBAKA DO SZYB

Blades for window scraper • Лезвие для скребка для стекол • Ersatzklingen für Glasschaber • Lame pentru răzuitor de geamuri

NUMER
KATALOGOWY



110 006

4 cm

1/10/120



SKROBAK DO SZYB

Window scraper • Скребок для стекол (цикля) • Glasschaber • Răzuitor geam

NUMER
KATALOGOWY



030 320

5 cm

1/25/100

SKROBAK MALARSKI

Paint Scraper • Малярный шабер • Farbschaber • Răzuitor geam

NUMER
KATALOGOWY



030 325

11 cm

1/100



ROLKA DO GŁADZI SZYBSZE I SKUTECZNIEJSZE ROZPROWADZANIE GŁADZI I MAS SZPACHLOWYCH.

Eliminuje potrzebę używania kielni, rajberek, pac, blichówek itp., których użytkowanie jest bardziej czasochłonne i wymaga częstszego uzupełniania materiału. W tym jednym narzędziu znajdziesz wszystko, czego potrzebujesz do skutecznego nakładania gładzi. Ściany, sufity, a nawet kąty i łuki nie stanowią wyzwania dla tego rodzaju wałka. Co więcej, dzięki odpowiedniej długości i gęstości włosa, już nigdy nie zużyjesz więcej gładzi niż potrzeba. Wysoka jakość wykonania wałka do gładzi jest gwarancją jego długotrwałej żywotności! Produkt testowany był przy użyciu gładzi wielu znanych producentów, takich jak Knauf, Semin, Siniat, Lakma, Cekol, Master Mas, Atlas GTA czy Kabe Profinisz.

GĘSTE I ELASTYCZNE POSZYCIE WAŁKA DOSKONALE POBIERA GŁADŹ I RÓWNIEŻ DOSKONALE ROZPROWADZA JĄ PO POWIERZCHNI

DWIE SZEROKOŚCI WAŁKA: 80 I 220 mm

OCYNKOWANY, SZTYWNY PRĘT O GRUBOŚCI 8 mm

motive
Jakość ma znaczenie



ERGONOMICZNY, WYGODNY W UŻYCIU DWUKOMPOZYTOWY UCHWYT TYPU SOFT
CAŁOWY GWINT ZAPEWNIAJĄCY SOLIDNE POŁĄCZENIE Z WIĘKSZOŚCIĄ KIJÓW TELESKOPOWYCH



WŁOSIE O DŁUGOŚCI 18 mm

DZIĘKI WYSOKIEJ JAKOŚCI WYKONANIA RUNA, WAŁEK NIE STRZĘPI SIĘ PODCZAS PRACY I NIE GUBI WŁÓKIEN

ROLKA DO GŁADZI Skim coat roller • Spachtel Rolle • Trafalet glet					
NUMER KATALOGOWY					
030 198	80 mm	18 mm	8 mm	1/100	
030 200	220 mm	18 mm	8 mm	1/30	

MYJKA DO WAŁKÓW MALARSKICH

GRATIS DLA CIEBIE

KRANIK DO REGULACJI
STRUMIENIA WODY
Z PRZYŁĄCZEM
DO WĘŻA



Nr kat. 030 335



PREZENTUJEMY WAM NOWOŚĆ! TYM RAZEM JEST TO MYJKA DO WAŁKÓW MALARSKICH. To przemyślane i opatentowane proste urządzenie, które jest bardzo przydatne dla osób zawodowo zajmujących się malowaniem. Do użycia myjki wystarczy w zasadzie tylko dostęp do węża z bieżącą wodą i wiadro jako zbiornik na brudną wodę. Myjka jest uniwersalna, przy jej pomocy umyjesz wałki o długości do 250 mm i średnicy z włosiem do 120 mm.



UNIWERSALNA

Myjka, którą wykorzystasz do mycia większości wałków malarskich dostępnych na rynku. Pasuje do wałków tradycyjnych, jak również koszykowych.

PROSTA W UŻYCIU

Do mycia wałków wystarczy dostęp do węża z bieżącą wodą i wiadro. Może to być wąż ogrodowy lub prysznicowy.

PRZEMYŚLANA

Dolne mocowania myjki dopasowane jest do większości okrągłych wiader po farbach, masach szpachlowych i gipsach, o pojemności 10 litrów.



NARZĘDZIA BUDOWLANE

СТРОИТЕЛЬНЫЕ ИНСТРУМЕНТЫ • CONSTRUCTION TOOLS

• BAUWERKZEUGE • UNELTE CONSTRUCTII



OPTICAL 6

MAKSYMALNE ULATWIENIE W TWOJEJ PRACY



PROFESJONALNA POZIOMICA OPTICAL 6 to dopracowane w każdym detalu narzędzie, którego zadaniem jest dokładne i szybkie wyznaczanie poziomów i pionów podczas Twojej pracy. Poziomica szczególnie dedykowana jest glazurnikom i budowlącom, którzy często dokonują pomiarów w różnych sytuacjach i pozycjach.

Dzięki poziomicy **Optical 6** dokonasz pomiaru praktycznie za każdym razem, kiedy weźmiesz ją do ręki, bez konieczności zbędnego jej obracania i szukania właściwej libelli.

AŻ 6 OCZEK POMIAROWYCH NA CAŁEJ DŁUGOŚCI POZIOMICY DLA WYGODNEGO I SZYBKIEGO ODCZYTU:

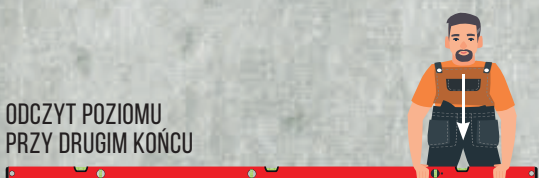
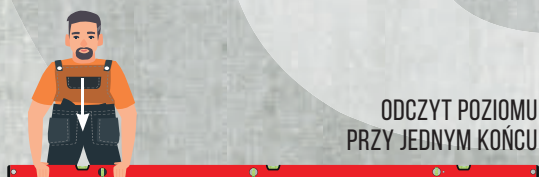
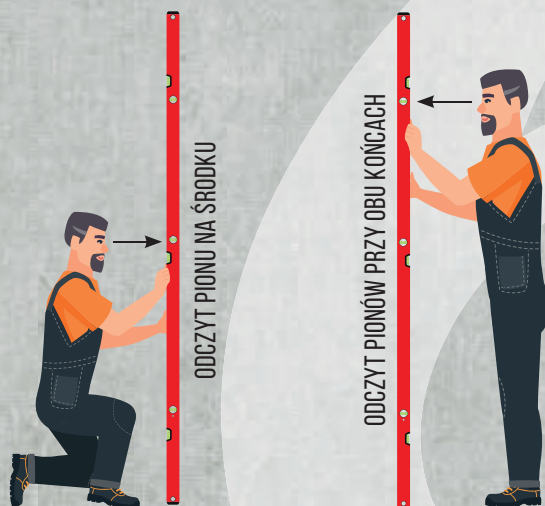

Libella "rybie oczko" umożliwiającą odczyt pod różnym kątem

Na libelli zaznaczony spadek 2% ułatwiający wykonanie tarasu lub odpływu

Dopracowany, sztywny i idealnie prosty profil aluminiowy, malowany proszkowo na kolor czerwony

Płyn stosowany w libellach nie ulega odbarwieniom, odporny jest na działanie temperatur od -20°C do +50°C

Gumowane zakończenia chroniące poziomice przed uszkodzeniem

Otwory do zawieszenia zlokalizowane na obu końcach poziomicy

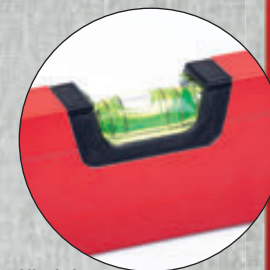

1

2

3

4

5

6

200 cm

Nr kat. 040 887

RAJBERKI

PROFESJONALNE PACE ELASTYCZNE

motive
Jakość ma znaczenie

HI-FLEX
RAJBERKI

Prezentujemy Wam kolejne profesjonalne narzędzia z rodziny **HI-FLEX**. Tym razem są to **ELASTYCZNE RAJBERKI**, które razem z kompletem szpachli Hi-Flex i wałkiem do nakładania gładzi Motive tworzą profesjonalny zestaw narzędzi do prac ze wszelkimi gotowymi masami typu "finisz". Dzięki nim wykonywana praca stanie się jeszcze dokładniejsza. Dopracowane do ostatniego detalu rajberki Hi-Flex pozwolą Wam łatwo, szybko i właściwie rozprowadzić każdą masę.

Wytrzymała aluminiowa stopka mocowana nitami

Zaokrąglone naroża części roboczej

Idealnie gładka spodnia część pacy, bez widocznych nitów mocujących

Elastyczna, kwasoodporna stal o grubości 0,3 mm

Mocowanie uchwyty wzmocnione taśmą, która dodatkowo zabezpiecza łączenie stopki z częścią roboczą pacy

Ergonomiczny, wygodny gumowy uchwyt

W SPRZEDAŻY DOSTĘPNE DWIE DŁUGOŚCI:

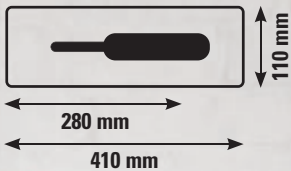

W komplecie zabezpieczające, plastikowe osłony na ostrza

RAJBERKI HI-FLEX

Finishing trowel Hi-Flex • Doppelblatt
Glättkelle Hi-Flex • Gletiera finisaj Hi-Flex

NUMER KATALOGOWY



040 940 280 mm 1/2

040 942 410 mm 1/3

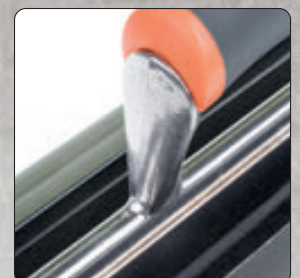
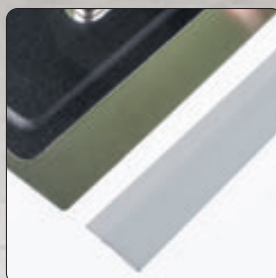

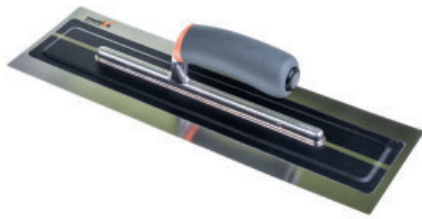

RAJBERKA NIERDZEWNA STOPKA ALUMINIOWA

Plastering trowel, stainless steel, soft-grip handle • Гладилка нерж. на алюмин. подст. • Glättkelle mit Soft-Griff • Gletiera otel inoxidabil

NUMER KATALOGOWY			
040 940	11 cm	28 cm	1/2
040 942	11 cm	41 cm	1/3



RAJBERKA NIERDZEWNA STOPKA ALUMINIOWA

Plastering trowel, stainless steel, soft-grip handle • Гладилка нерж. на алюмин. подст. • Glättkelle mit Soft-Griff • Gletiera otel inoxidabil

NUMER KATALOGOWY			
040 750	13 cm	28 cm	1/10



RAJBERKA NIERDZEWNA ZĘBATA STOPKA ALUMINIOWA

Square notched tiling trowel, soft-grip handle • Гладилка нерж. на алюмин. подст. • Glättkelle gezahnt mit Soft-Griff • Gletiera inox

NUMER KATALOGOWY				
040 751	13 cm	27 cm	4 mm	1/10
040 752	13 cm	27 cm	6 mm	1/10
040 753	13 cm	27 cm	8 mm	1/10
040 754	13 cm	27 cm	10 mm	1/10



RAJBERKA ALU. UCHWYT KOREK

Cork grip handle plastering trowel • Гладилка нерж. на алюмин. подст., ручка из пробки • Glättkelle mit Korkgriff • Gletieră, mâner din plută

NUMER KATALOGOWY			
040 827	12 cm	28 cm	1/5
040 828	12 cm	36 cm	1/5
040 829	12 cm	48 cm	1/5



RAJBERKA WENECKA

Venetian plastering trowel • Гладилка венецкая • Venezianische Glättkelle • Gletiera rotunjita tip venetiana

NUMER KATALOGOWY			
040 755	7,5 x 9,5 cm	24 cm	1/10



RAJBERKA NIERDZEWNA ZĄB PÓŁOKRĄGŁY

U notched Trowel • Гладилка нерж. полукруглый зуб, ручка • Glättkelle halbrund zahn • Gletiera zimtata dinti profil semirotund

NUMER KATALOGOWY				
040 756	13 cm	27 cm	10 mm	1/10

motive
Jakość ma znaczenie



RAJBERKA NIERDZ. DO GIPSU ALUMINIOWA

Wooden grip handle plaster finishing trowel • Гладилка нерж. для гипса ал. • Trockenbau Glättkelle • Gletiera otel inoxidabil

NUMER KATALOGOWY			
040 148	12 cm	40 cm	1/6



RAJBERKA NIERDZEWNA STOPKA ALUMINIOWA

Plastering trowel, stainless steel, wooden handle • Гладилка нерж. на алюмин. подст. • Glättkelle rostfrei • Gletiera otel inoxidabil

NUMER KATALOGOWY			
040 114	13 cm	27 cm	1/10



RAJBERKA NIERDZEWNA ZĘBATA STOPKA ALUMINIOWA

Square notched tiling trowel, wooden handle • Гладилка нерж. на алюмин. подст. • Glättkelle gezahnt • Gletiera zimtata

NUMER KATALOGOWY				
040 110	13 cm	27 cm	4 mm	1/10
040 111	13 cm	27 cm	6 mm	1/10
040 112	13 cm	27 cm	8 mm	1/10
040 113	13 cm	27 cm	10 mm	1/10



RAJBERKA NIERDZ. 13/28 PL GAT. I

Plastering trowel, stainless steel, plastic handle, I quality • Гладилка нерж. с пластм. ручк. сорт 1 • Glättkelle mit Kunststoffgriff • Gletiera inox

NUMER KATALOGOWY			
040 144	13 cm	27 cm	1/10





RAJBERKA NIERDZ. 13/28 PL GAT.II

Plastering trowel, stainless steel, plastic handle, II quality • Гладилка нерж. с пластм. ручк. сорт 2 • Glättkelle mit Kunststoffgriff • Gletiera inox

NUMER KATALOGOWY			
040 145	13 cm	27 cm	1/10



RAJBERKA NIERDZEWNA ZĘBATA

Square notched tiling trowel • Гладилка нерж. с пластм. ручк. Зубчатая • Glättkelle mit Kunststoffgriff • Gletiera zimtata

NUMER KATALOGOWY				
040 140	13 cm	27 cm	4 mm	1/10
040 141	13 cm	27 cm	6 mm	1/10
040 142	13 cm	27 cm	8 mm	1/10
040 143	13 cm	27 cm	10 mm	1/10
040 146	13 cm	27 cm	12 mm	1/10



RAJBERKA NIERDZEWNA UCHWYT DREWNIANY

Plastering trowel, stainless steel, wooden handle • Гладилка нерж. с деревян. ручкой • Schweizer Glättkelle rostfrei • Gletiera otel tip elvetiana

NUMER KATALOGOWY			
040 124	13 cm	38 cm	1/10
040 123	13 cm	48 cm	1/10
040 125	13 cm	58 cm	1/18
040 127	13 cm	78 cm	1/18



RAJBERKA NIERDZEWNA UCHWYT DREWNIANY

Square notched tiling trowel, wooden handle • Гладилка нерж. с деревян. ручкой • Schweizer Glättkelle rostfrei • Gletiera otel inoxidabil

NUMER KATALOGOWY				
040 120	13 cm	48 cm	6 mm	1/10
040 121	13 cm	48 cm	8 mm	1/10
040 122	13 cm	48 cm	10 mm	1/10



RAJBERKA NIERDZEWNA UCHWYT PLASTIKOWY

Plastering trowel, stainless steel, plastic handle • Гладилка нерж. • Schweizer Glättkelle mit Kunststoffgriff • Gletiera inox

NUMER KATALOGOWY			
040 151	13 cm	48 cm	1/10



RAJBERKA PLASTIKOWA

Plastic trowel • Гладилка пластмассовая • Glättkelle Plastik • Drisca plastic

NUMER
KATALOGOWY



040 102

13 cm

27 cm

1/10



RAJBERKA ABS

Plastic trowel ABS • Гладилка ABS • Glättkelle Kunststoff • Drisca plastic ABS

NUMER
KATALOGOWY



040 101

13 cm

27 cm

10



PACA STYROPIANOWA

Foamed polystyrene float • Терка из пенопласта • Styropor-Reibebrett
• Drisca polistiren

NUMER
KATALOGOWY



040 045

13 cm

27 cm

10

040 046

13 cm

40 cm

10

040 047

13 cm

60 cm

10

040 048

13 cm

70 cm

10

040 049

14 cm

100 cm

10

040 050

32 cm

17 cm

10



PACA STYROPIANOWA Z GĄBKĄ MIĘKKĄ

Foamed polystyrene float with soft sponge • Терка из пенопласта с мягкой губкой • Styropor-Reibebrett mit feinporigen Schwamm
• Gletiera polistiren cu burete fin

NUMER
KATALOGOWY



040 056

14 cm

28 cm

10



PACA STYROPIANOWA Z GĄBKĄ TWARDĄ

Foamed polystyrene float with tough sponge • Терка из пенопласта с твердой губкой • Styropor-Reibebrett mit grobporigen Schwamm
• Gletiera polistiren cu burete poros

NUMER
KATALOGOWY



040 057

14 cm

28 cm

10





PACA STYROPIANOWA Z FILCEM 5 mm

Foamed polystyrene float with felt 5 mm • Терка из пенопласта с фетровой накладкой 5 мм • Styropor-Reibebrett mit Filz • Gletiera polistiren cu pãslă

NUMER
KATALOGOWY



040 055

14 cm

28 cm

10



PACA POLIURETANOWA

Polyurethane float • Терка полиуретановая • Polyurethan-Reibebrett
• Drisca poliuretan

NUMER
KATALOGOWY



040 051

14 cm

28 cm

1/6/36

040 052

18 cm

32 cm

1/6/36



motive
Jakość ma znaczenie



PACA Z FILCEM 8 mm

Plastic trowel with felt 8 mm • Терка пласт. с фетровой накладкой 8 мм
• Reibebrett mit Filz • Drisca cu pasla

NUMER
KATALOGOWY



040 080

14 cm

28 cm

1/10



motive
Jakość ma znaczenie



PACA Z GĄBKĄ GUMOWĄ 18 mm

Plastering sponge trowel • Терка пласт. с резиновой губкой 18 мм
• Reibebrett mit grobporigen Schwammgummi • Gletiera cu burete cauciucati

NUMER
KATALOGOWY



040 081

14 cm

28 cm

1/10



motive
Jakość ma znaczenie



PACA PRZEGUBOWA Z HYDROGUMĄ

Celling sponge float • Поплавок из ПВХ материала с гидрорезиной
• Deckenreibebrett • Raspel de aluminiu cu burete

NUMER
KATALOGOWY



040 078

20 cm

40 cm

1/10



PACA Z GĄBKĄ PONACINANĄ HYDRO 30 mm

Trowel with scatching sponge HYDRO 30 mm • Терка пласт. с надрезанной резиновой губкой HYDRO 30 мм • Fliesenwaschbrett Hydro gerastert • Drisca burete hidro-absorbant profilatą

NUMER KATALOGOWY			
040 086	14 cm	28 cm	1/10

PACA Z GĄBKĄ PONACINANĄ 25 mm

Tiling float with scatching sponge 25 mm • Терка пласт. с надрезанной резиновой губкой 25 мм • Fliesenwaschbrett gerastert • Drisca burete

NUMER KATALOGOWY			
040 082	14 cm	28 cm	1/10

PACA Z GĄBKĄ POROWATĄ 25 mm

Tiling float with sponge 25 mm • Терка пласт. с мягкой пористой губкой 25 мм • Reibebrett mit feinporigen Schwamm • Drisca burete

NUMER KATALOGOWY				
040 083	MIĘKKA/SOFT	14 cm	28 cm	1/10
040 084	TWARDA/HARD	14 cm	28 cm	1/10

PACA Z GUMĄ 8 mm

Grout float 8 mm • Терка с рез. покрытием 8 mm • Reibebrett mit Gummi • Drisca cauciuc

NUMER KATALOGOWY			
040 085	14 cm	28 cm	1/10

PACA Z FILCEM 5 mm

Plastering trowel with felt 5 mm • Терка пласт. с фетровой накладкой 5 мм • Reibebrett Filz 5 mm

NUMER KATALOGOWY			
040 060	14 cm	28 cm	1/10

ZAPAS FILC 8 mm

Felt refill 8 mm • Фетровые накладки 8 мм • Filz 8 mm für Reibebrett • Rezerva pâslă pentru gletiera

040 061	14 cm	28 cm	1/10
---------	-------	-------	------

motive
Jakość ma znaczenie

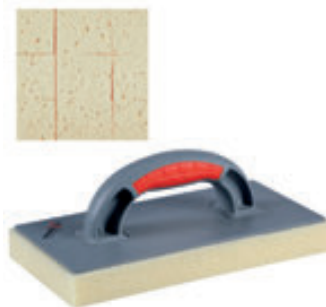

motive
Jakość ma znaczenie



motive
Jakość ma znaczenie



motive
Jakość ma znaczenie





PACA Z GĄBKĄ HYDROCHŁONNĄ PONACINANĄ 30 mm

Trowel with scatching sponge 30 mm • Терка пласт. с надрезанной резиновой губкой 30 мм • Fliesenwaschbrett • Drisca burete hidro-absorbant profilată

NUMER
KATALOGOWY



040 066

13,5 cm

27,5 cm

1/10

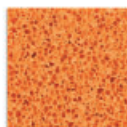

PACA Z GĄBKĄ GUMOWĄ 18 mm

Plastic trowel with rubber sponge 18 mm • Терка пласт. с резиновой губкой 18 мм • Reibebrett mit Schwammgummi • Drisca burete

NUMER
KATALOGOWY



040 065

14 cm

28 cm

1/10



PACA Z GĄBKĄ POROWATĄ MIĘKKĄ

Plastic trowel with soft sponge • Терка пласт. с мягкой пористой губкой • Reibebrett mit feinporigen Schwamm • Drisca burete fin

NUMER
KATALOGOWY



040 070

14 cm

28 cm

1/10



PACA Z GĄBKĄ PONACINANĄ 30 mm

Trowel with scatching sponge 30 mm • Терка пласт. с надрезанной резиновой губкой 30 мм • Fliesenwaschbrett • Drisca burete

NUMER
KATALOGOWY



040 072

14 cm

28 cm

1/10



PACA Z GĄBKĄ POROWATĄ TWARDA

Plastic trowel with tough sponge • Терка пласт. с тверд. пористой губкой • Reibebrett mit grobporigen Schwamm • Drisca burete spongios

NUMER
KATALOGOWY



040 071

14 cm

28 cm

1/10



PACA Z GUMA

Grout float • Терка с рез. покрытием • Reibebrett Moosgummi • Drisca cauciuc

NUMER
KATALOGOWY



040 075

14 cm

28 cm

1/10



PACA TARKA PRZELOTOWA

Polystyrene rasp with through holes • Тёрка для пенопласта • Schleifbrett für Styropor • Razuator polistiren

NUMER KATALOGOWY			
040 037	18 cm	40 cm	1/5

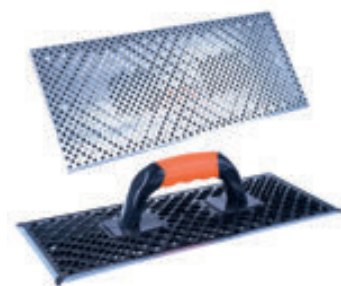

PACA TARKA PEŁNA

Heavy duty polystyrene rasp • Тёрка для пенопласта усиленная • Schleifbrett • Razuator polistiren

NUMER KATALOGOWY			
040 053	13 cm	27 cm	1/10



PACA TARKA PRZELOTOWA WZMOCNIONA

Heavy duty polystyrene rasp • Тёрка для пенопласта усиленная • Schleifbrett • Razuator polistiren

NUMER KATALOGOWY			
040 054	13 cm	27 cm	1/10
040 038	16 cm	38 cm	1/10



PACA TARKA

Polystyrene rasp • Тёрка для пенопласта • Schleifbrett für Styropor • Razuator polistiren

NUMER KATALOGOWY			
040 040	13 cm	27 cm	1/10
040 041	18 cm	40 cm	1/10

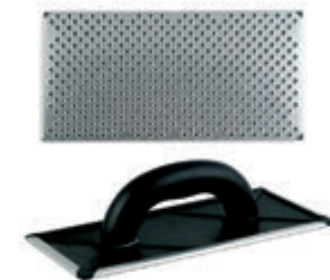

ZDZIERAK DO TYNKÓW METAL

Render scraper • Скребок для штукатурки металл • Putzkratzer • Răbot pentru tencuială

NUMER KATALOGOWY			
040 044	13 cm	25 cm	1/10

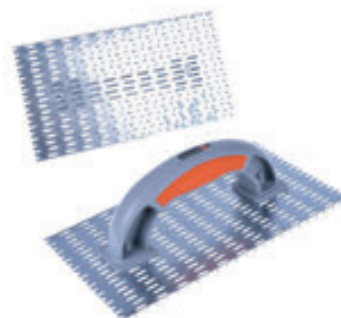



ZDZIERAK DO TYNKÓW

Plaster rasp • Скребок для штукатурки • Putzhobel • Robot pentru tencuiala

NUMER
KATALOGOWY



040 042

8 cm

40 cm

1/10



ZDZIERAK ALUMINIOWY

Plaster alu rasp • Скребок алюминиевый • Putzhobel ALU
• Robot aluminiu pentru tencuiala

NUMER
KATALOGOWY



040 043

9 cm

45 cm

1/20



KIELNIA FUGOWA NIERDZEWNA

Tuck Pointing Trowel, stainless steel • Шпатель для швов нержав.
• Fugenkelle, rostfrei • Mistrie rosturi pentru zidarie

NUMER
KATALOGOWY



040 701

8 mm

1/10

040 702

10 mm

1/10

040 703

12 mm

1/10



KIELNIA KĄTOWA WEWNĘTRZNA

Internal corner trowel • Кельма угловая внутренняя • Eckenkelle innen
• Mistrie colt interior

NUMER
KATALOGOWY



040 720

65 mm

80 mm

1/10



KIELNIA KĄTOWA ZEWNĘTRZNA

External corner trowel • Кельма угловая внешняя • Eckenkelle außen
• Mistrie colt exterior

NUMER
KATALOGOWY



040 721

65 mm

80 mm

1/10



KIELNIA SZTUKATORSKA NIERDZEWNA

Margin trowel, stainless steel • Кельма штукатурная нерж.
• Stukkateurspachtel • Mistrie dreapta

NUMER KATALOGOWY		
040 725	50 mm	1/10
040 726	80 mm	1/10
040 727	100 mm	1/10
040 728	120 mm	1/10

motive
Jakość ma znaczenie



KIELNIA SZTUKATORSKA KOREK

Stucco trowel, stainless steel, cork grip handle • Кельма штукатурная нерж.,
ручка из пробки • Stukkateurspachtel mit Korkgriff • Mistrie dreapta

NUMER KATALOGOWY		
040 823	60 mm	1/5
040 824	80 mm	1/5
040 825	100 mm	1/5
040 826	120 mm	1/5

motive
Jakość ma znaczenie



KIELNIA NIERDZEWNA TRAPEZOWA

Stainless steel bucket trowel • Кельма трапеция нерж.
• Maurerkelle, rostfrei • Mistrie trapez

NUMER KATALOGOWY		
040 730	130 mm	1/10
040 731	160 mm	1/10
040 732	180 mm	1/10

motive
Jakość ma znaczenie



KIELNIA TRAPEZOWA KOREK

Bricklayer trapeze shape, stainless steel, cork grip handle • Кельма трапеция
нерж., ручка из пробки • Maurerkelle, rostfrei • Mistrie trapez

NUMER KATALOGOWY		
040 820	140 mm	1/5
040 821	160 mm	1/5
040 822	180 mm	1/5

motive
Jakość ma znaczenie



KIELNIA TRÓJKĄTNA NIERDZEWNA

Bricklaying trowel, stainless steel • Кельма треугольная нерж.
Berliner Maurerkelle • Mistrie triunghiulara

NUMER KATALOGOWY		
040 705	180 mm	1/10
040 706	200 mm	1/10

motive
Jakość ma znaczenie





motive
Jakość ma znaczenie



KIELNIA TRÓJKĄTNA SZLIFOWANA

Grinded triangular brick trowel • Кельма треугольная шлифованная
• Mistrie triunghiulara

NUMER KATALOGOWY		
040 711	180 mm	1/10
040 712	200 mm	1/10
040 713	220 mm	1/10



EDELSTAHL
Rostfrei

KIELNIA FUGOWA NIERDZEWNA

Tuck Pointing Trowel, stainless steel • Шпатель для швов нержав.
• Fugenkelle, rostfrei • Mistrie rosturi pentru zidarie

NUMER KATALOGOWY		
040 001	8 mm	1/10/50
040 002	10 mm	1/10/50
040 003	12 mm	1/10/50



EDELSTAHL
Rostfrei

KIELNIA KĄTOWA WEWNĘTRZNA

Internal corner trowel • Кельма угловая внутренняя • Eckenkelle innen
• Mistrie colt interior

NUMER KATALOGOWY			
040 020	65 mm	80 mm	1/10/50



EDELSTAHL
Rostfrei

KIELNIA KĄTOWA ZEWNĘTRZNA

External corner trowel • Кельма угловая внешняя • Eckenkelle außen
• Mistrie colt exterior

NUMER KATALOGOWY			
040 021	65 mm	80 mm	1/10/50



EDELSTAHL
Rostfrei

KIELNIA SZTUKATORSKA NIERDZEWNA

Margin trowel • Кельма штукатурная нерж. • Stukkateurspachtel, rostfrei
• Mistrie dreapta

NUMER KATALOGOWY		
040 025	50 mm	1/10/50
040 026	80 mm	1/10/50
040 027	100 mm	1/10/50



KIELNIA NIERDZEWNA TRAPEZOWA

Stainless steel bucket trowel • Кельма трапеция нерж. • Maurerkelle, rostfrei
 • Mistrie trapez

NUMER KATALOGOWY		
040 030	130 mm	1/10/50
040 031	160 mm	1/10/50
040 032	180 mm	1/10/50



KIELNIA TRAPEZOWA CZARNA

Bucket trowel, black • Кельма трапеция черная • Trapezkelle, schwarz
 • Mistrie trapez

NUMER KATALOGOWY		
040 009	130 mm	1/50
040 010	180 mm	1/50
040 011	200 mm	1/50



KIELNIA TRÓJKĄTNA NIERDZEWNA

Bricklaying trowel, rostfrei • Кельма треугольная нерж. • Berliner Maurerkelle
 • Mistrie triunghiulara

NUMER KATALOGOWY		
040 005	180 mm	1/10/25
040 006	200 mm	1/10/25



KIELNIA MURARSKA CZARNA

Bricklaying trowel, black • Кельма каменщика • Berliner Maurerkelle
 • Mistrie triunghiulara

NUMER KATALOGOWY		
040 015	180 mm	1/50
040 016	200 mm	1/50



KIELNIA DO GAZOBETONU

Trowel for aerated concrete • Кельма по газобетону • Porenbetonkelle
 • Mistrie BCA

NUMER KATALOGOWY		
040 035	115 mm	1/10
040 036	240 mm	1/10





motive
Jakość ma znaczenie

SZPACHLE Z WYMIENNYMI OSTRZAMI

ALUMINIOWE SZPACHLE DO MAS GIPSOWYCH, tynków cementowo-wapiennych, kwarcowych, jak również lekkich tynków maszynowych, a nawet klejów. Aluminiowe szpachle Motive to precyzyjne narzędzia do wydajnej pracy przy nakładaniu wspomnianych mas na powierzchnię ścian i sufitów. Wykonane są z solidnego anodowanego profilu aluminiowego, dzięki czemu łatwo doprowadzisz je do czystości po zakończonej pracy. Niewątpliwie atutem naszych szpachli jest wygoda ich użytkowania oraz łatwa wymiana ostrzy, co daje użytkownikowi możliwość pracy z różnymi masami.



250

400

600

800



Zaokrąglone naroża części roboczej

Korpus z anodowanego, wzmocnionego wewnątrz profilu

Wygodny, ergonomiczny kształt



ŁATWA WYMIANA OSTRZA:
ODKRĘCASZ • ZDEJMUJESZ ZAŚLEPKĘ • WYSUWASZ
OSTRZE • WSUWASZ NOWE OSTRZE • ZAKŁADASZ
ZAŚLEPKĘ • PRZYKRĘCASZ



ALUMINIOWE SZPACHLE DO MAS

Skimming spatula • Шпатель • Flächenspachtel • Gletiera profesionala

NUMER KATALOGOWY	↔	
040 842	250 mm	1
040 855	400 mm	1
040 830	600 mm	1
040 831	800 mm	1
040 832	1000mm	1



OSTRZA DO SZPACHLI

Skimming spatula blade • Лезвие для шпателя алю для гипса
• Ersatzklinge für Flächenspachtel • Lama pentru spatula

NUMER KATALOGOWY	↓	↔	
040 843	0,3 mm	250 mm	1/50
040 854	0,3 mm	400 mm	1/20
040 833	0,3 mm	600 mm	1/20
040 834	0,3 mm	800 mm	1/20
040 835	0,3 mm	1000 mm	1/20
040 839	0,5 mm	600 mm	1/20
040 840	0,5 mm	800 mm	1/20

ADAPTER DO SZPACHLI ALUMINIOWYCH

ADAPTER DO SZPACHLI ALUMINIOWYCH

Skimming spatula adaptor • Адаптер для шпателя • Adapter für Flächenspachtel mit Wechselblattsystm • Maner-Adaptor pentru gletiera profesionala

NUMER KATALOGOWY	
040 851	1/4



Regulacja kąta nachylenia adaptera

Dwie klamry zatrzaskowe do szybkiego montażu

Dwa sposoby mocowania kija teleskopowego (gwint/wcisk)

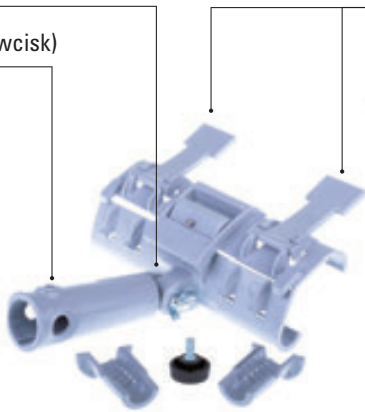

POŁĄCZENIE WKRĘCANE

Pasuje do większości kijów teleskopowych z końcówką z gwintem amerykańskim (patrz: katalog str. 91-92)

POŁĄCZENIE WCISKANE

Pasuje do kijów teleskopowych z typową końcówką stożkową (patrz: katalog str. 91-92)



ZESTAW SZPACHLI Z WALIZKĄ / WALIZKA

Skimming spatula set in box • Flächenspachtel-Set im Koffer
• Set pentru glet

NUMER KATALOGOWY		↔		
	030 507	Kij teleskopowy	0,8-1,4 m	1
	040 842	Szpachla do gładzi	250 mm	1
	040 855	Szpachla do gładzi	400 mm	1
040 849	040 830	Szpachla do gładzi	600 mm	1
	040 831	Szpachla do gładzi	800 mm	1
	040 832	Szpachla do gładzi	1000 mm	1
	040 851	Adapter do szpachli		1
	040 845	Zestaw szpachli z walizką + rolka do gładzi		1



SZPACHLE POWIERZCHNIOWE RE-FLEX

SZPACHLE POWIERZCHNIOWE RE-FLEX to produkt, który zadowolili każdego fachowca od nakładania gładzi lub tynków. Dzięki szpachlom RE-FLEX idealnie gładkie ściany i perfekcyjne wykończenie są dosłownie na wyciągnięcie ręki.

PIĘĆ DŁUGOŚCI SZPACHLI

W ofercie pięć długości szpachli, co daje gwarancję udanej pracy na każdej powierzchni.



ŁATWA WYMIANA OSTRZY

W standardzie nierdzewne i elastyczne ostrza o grubości 0,3 mm. Dostępne są również ostrza mocniejsze, o grubości 0,5 mm.



LEKKI PROFIL Z TWORZYWA SZTUCZNEGO

Lekki i ergonomiczny profil to duże ułatwienie, zwłaszcza dla osób wykonujących gładzie przez kilka godzin dziennie i to na dużych powierzchniach.

WSPÓŁPRACA Z ADAPTEREM I KIJEM TELESKOPOWYM

Kompatybilność szpachli z adapterem, który wraz z kijem teleskopowym pozwala sięgnąć dalej i wyżej, daje większy zasięg i swobodę ruchu. To mniej wdrapywania się na drabinę i znacznie łatwiejszy dostęp do wysokich i oddalonych od nas miejsc.

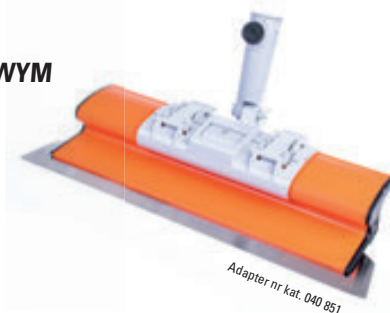

SZPACHLE DO GŁADZI

Skimming spatula Re-Flex
• Flächenspachtel Re-Flex • Gletiera profesionala Re-Flex

NUMER KATALOGOWY	↔	
040 910	250 mm	1
040 911	450 mm	1
040 912	600 mm	1
040 913	800 mm	1
040 914	1000 mm	1

ZESTAW SZPACHLI Z WALIZKĄ / WALIZKA

Skimming spatula set in box/Case • Flächenspachtel-Set im Koffer/
Koffer für Flächenspachtel-Set • Prelungitor cu maner pt gletiera profesionala

NUMER KATALOGOWY	↔		
040 920	Kij teleskopowy	1m - 2 m	1
040 950	Szpachla do gładzi	250 mm	1
040 951	Szpachla do gładzi	450 mm	1
040 952	Szpachla do gładzi	600 mm	1
040 953	Szpachla do gładzi	800 mm	1
040 954	Szpachla do gładzi	1000 mm	1





motive
Jakość ma znaczenie

SZPACHLE DO MAS

HI-FLEX
SZPACHLE I KIJE TELESKOPOWE

SZPACHLE I KIJE TELESKOPOWE DO GŁADZI HI-FLEX są doskonałymi narzędziami do wydajnej pracy przy nakładaniu gładzi na ścianach i sufitach. Występujące w pięciu szerokościach szpachle oraz dostępne w dwóch długościach kije teleskopowe to niezbędny i profesjonalny system do szybkiego rozprowadzania mas na dużych powierzchniach



PIĘĆ SZEROKOŚCI SZPACHLI DO WYBORU

ERGONOMICZNA, WYPROFILOWANA OBUDOWA
Z ODPORNEGO TWORZYWA SZTUCZNEGO

ELASTYCZNE OSTRZE WYKONANE
Z NIERDZEWNEJ BLACHY O GRUBOŚCI 0,31 mm

DOSTĘPNE KIJE TELESKOPOWE
Z ZAKRESEM PRACY OD 1 m DO 4 m

ŁATWA REGULACJA DŁUGOŚCI
KIJA TELESKOPOWEGO

SZPACHLE DO GŁADZI

Skimming spatula Hi-Flex • Flächenspachtel Hi-Flex
• Gletiera profesionala Hi-Flex

NUMER KATALOGOWY	↔	
040 910	250 mm	1
040 911	450 mm	1
040 912	600 mm	1
040 913	800 mm	1
040 914	1000 mm	1

KIJE TELESKOPOWE Z ADAPTEREM

Extendable alloy handle • Verlängerungsstab für
Flächenspachtel • Prelungitor cu maner pt gletiera
profesionala

040 920	1 m - 2 m	1
040 921	2 m - 4 m	1



ZESTAW SZPACHLI Z WALIZKĄ / WALIZKA

Skimming spatula set in box/ Hi-Flex box • Flächenspachtel-Set
im Koffer/ Koffer für Flächenspachtel-Set • Prelungitor cu maner pt
gletiera profesionala

NUMER KATALOGOWY	↔	
040 920	Kij teleskopowy	1m - 2 m 1
040 910	Szpachla do gładzi	250 mm 1
040 911	Szpachla do gładzi	450 mm 1
040 912	Szpachla do gładzi	600 mm 1
040 913	Szpachla do gładzi	800 mm 1
040 914	Szpachla do gładzi	1000 mm 1
040 904	WALIZKA (bez wyposażenia)	1



SZYBKI MONTAŻ
SZPACHLI Z KIJEM
TELESKOPOWYM (PRZYDATNE
PRZY PRACY NA WIĘKSZYCH WYSOKOŚCIACH)



SZPACHLA FASADOWA SOFT

Taping knife, stainless steel, soft handle • Шпатель фасадный "SOFT"
• Fassadenspachtel Soft • Spaclu inox

NUMER KATALOGOWY			
040 180	60 mm	150 mm	1/10
040 181	60 mm	250 mm	1/10
040 182	60 mm	350 mm	1/10
040 183	60 mm	450 mm	1/10
040 184	60 mm	550 mm	1/10



SZPACHLA FASADOWA SOFT

Taping knife, stainless steel, soft handle • Шпатель фасадный "SOFT"
• Fassadenspachtel Soft • Spaclu inox

NUMER KATALOGOWY			
040 190	90 mm	150 mm	1/10
040 191	90 mm	250 mm	1/10
040 192	90 mm	350 mm	1/10
040 193	90 mm	450 mm	1/10
040 194	90 mm	550 mm	1/10



ADAPTER DO SZPACHLI FASADOWYCH

Taping knife adaptor • Адаптер для шпателя Motive
• Stielhalter für Flächenspachtel • Suport pentru coadă

NUMER KATALOGOWY	
040 852	1/50

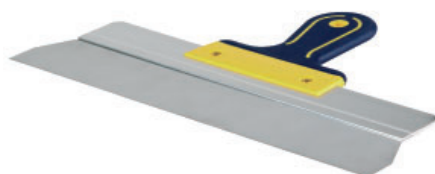

SZPACHLA NIERDZEWNA SOFT

Taping knife, stainless steel, soft handle • Шпатель нерж. "SOFT"
• Fassadenspachtel mit Softgriff • Spaclu inox

NUMER KATALOGOWY			
040 164	60 mm	150 mm	1/10/50
040 165	60 mm	250 mm	1/10/50
040 166	60 mm	350 mm	1/10/50
040 167	60 mm	400 mm	1/10/30
040 169	60 mm	600 mm	1/10/30



SZPACHLA NIERDZEWNA FASADOWA

Taping knife, plastic handle • Шпатель фасадный нерж.
• Fassadenspachtel mit Kunststoffgriff • Spaclu inox

NUMER KATALOGOWY			
040 254	60 mm	150 mm	1/20
040 255	60 mm	250 mm	1/10
040 256	60 mm	350 mm	1/10
040 257	60 mm	450 mm	1/10
040 258	60 mm	600 mm	1/10



SZPACHLA NIERDZEWNA ZĘBATA

Scraper with teeth • Шпатель нерж. зубчатый • Fassadenspachtel rostfrei
• Spaclu inox

NUMER KATALOGOWY			
040 201	150 mm	6 mm	1/20
040 202	250 mm	6 mm	1/10
040 203	150 mm	8 mm	1/20
040 204	250 mm	8 mm	1/10



SZPACHELKA NIERDZEWNA

Stainless steel putty knife, soft handle • Шпатель нерж. • Rostfrei Spachtel
• Şpaclu inoxidabil

NUMER KATALOGOWY		
040 240	40 mm	1/12/120
040 241	60 mm	1/12/120
040 242	80 mm	1/12/120
040 243	100 mm	1/12/120
040 244	120 mm	1/12/120
040 245	150 mm	1/12/120



SZPACHELKA WIELOFUNKCYJNA 6 W 1

Multipurpose scraper • Многофункциональный шпатель
• Multifunktionspachtel • Şpaclu multifunctional

NUMER KATALOGOWY		
040 247	76 mm	1/12/120



SZPACHELKA NIERDZEWNA Z BITEM

Stainless steel scraper with bit • Шпатель нержавеющей специальный
• Şpaktelălapstîna, nerûsëjoša tërauda • Fugenspachtel mit PH2-Bit
• Şpaclu cu şurubelnişă

NUMER KATALOGOWY		
040 249	150 mm	1/12/120





SZPACHELKA NIERDZEWNA

Stainless steel putty knife, plastic handle • Шпатель нерж. • Rostfrei Spachtel mit Kunststoffgriff • Spaclu inox cu maner plastic

NUMER KATALOGOWY	↔	
040 250	40 mm	20
040 251	60 mm	20
040 252	80 mm	20
040 253	100 mm	20



SZPACHELKA - SKROBAK

Heavy duty scraper • Скребок с закаленным лезвием • Stoßspachtel • Spaclu cu maner lemn

NUMER KATALOGOWY	↔	
040 259	70 mm	1



SZPACHELKA MALARSKA

Putty knife, wooden handle • Шпатель с деревянной ручкой • Malerspachtel • Spaclu pentru zugravi

NUMER KATALOGOWY	↔	
040 230	40 mm	1/12/240
040 231	50 mm	1/12/240
040 232	60 mm	1/12/240
040 233	80 mm	1/12/240
040 234	100 mm	1/12/240



SZPACHELKI JAPONKI METALOWE

Metal scrapers 4 pcs set • Шпателя металлические "JAPAN" 4 шт. • Japanspachtel-Set aus Stahl • Set spaclu japonez - metal

NUMER KATALOGOWY		
040 210	5/8/10/12 cm	1/10/120



SZPACHELKI JAPONKI PLASTIKOWE

Plastic scrapers set 4 pcs set • Шпатель пластмассовые "JAPAN" 4 шт.
• Japanspachtel Set - Kunststoff • Set spaclu japonez - plastic



NUMER
KATALOGOWY



040 211

5/8/10/12 cm

1/10/200

KUWETA DO SZPACHLOWANIA

Plastic mud pan • Кювета для шпатлевки • Spachtelkasten Kunststoff
• Tavita pentru mortar



NUMER
KATALOGOWY



040 901

350 x 120 x 90 mm

1

MIESZADŁO DO ZAPRAW M-14

Paddle mixer M14 • Миксер для смесей M-14 • Mörtelrührer M14
• Mixer pentru mortar M14



NUMER
KATALOGOWY



040 274

100 mm

1/12

040 276

120 mm

1/12

040 275

135 mm

1/12

MIESZADŁO ŚLIMAKOWE DO ZAPRAW

Concrete mixing paddle • Миксер для смесей "УЛИТКА" • Mörtelstab • Mixer
pentru materiale de constructii

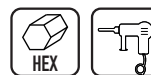

NUMER
KATALOGOWY



040 288

90 mm

1/40

040 289

100 mm

1/20

MIESZADŁO DO GIPSU

Mixer paddle for plaster • Миксер для гипса • Gipsrührer
• Mixer clopot pentru materiale de constructii



NUMER
KATALOGOWY



040 283

80 mm

1/50

040 284

100 mm

1/50



SDS

MIESZADŁO DO ZAPRAW SDS

SDS mixing paddle • Миксер для смесей SDS • SDS Mörtelrührer
• Mixer pentru mortar SDS

NUMER KATALOGOWY		
040 278	100 mm	1/6/24
040 279	120 mm	1/6/24



MIESZADŁO DO FARB

Paint mixing paddle • Миксер для красок • Farbrührer • Mixer pentru vopsea

NUMER KATALOGOWY		
040 280	50 mm	1/6/48
040 281	80 mm	1/6/48
040 282	100 mm	1/6/48



MIESZADŁO OCYNKOWANE

Galvanized mixing paddle • Миксер для смесей оцинкованный
• Verzinkt Rührstab • Mixer spirala pentru materiale de constructii

NUMER KATALOGOWY		
040 285	60 mm	1/6
040 286	80 mm	1
040 287	100 mm	1



CZERPAK MURARSKI

Bricklayer scoop • Черпак каменщика • Maurerschöpfkelle • Cancioc zidar

NUMER KATALOGOWY		
040 270	163 mm	1/50



motive
Jakość ma znaczenie



MISECZKA DO GIPSU

Flexible, plaster mixing bowl • Емкость для гипса • Gipsbecher
• Vas pentru ipsos

NUMER KATALOGOWY		
040 265	600 ml	1/10/240



MISECZKA DO GIPSU

Plaster bowl • Емкость для гипса • Gipsbecher • Vas pentru ipsos



NUMER
KATALOGOWY



040 300

0.5 L

1/20

POJEMNIK OKRĄGŁY

Round mixing tub • Ведро белое с крышкой • Mörtelkübel
• Vas pentru constructii

NUMER
KATALOGOWY



040 290

45 L

1/240

040 291

65 L

1/212

040 292

90 L

1/212



POJEMNIK ELASTYCZNY

Flexible mixing tub • Ведро гибкое • Flexibler Kübel • Cos flexibil cu manere



NUMER
KATALOGOWY



040 997

80 kg

27 L

1/720

040 998

100 kg

42 L

1/600

040 999

120 kg

55 L

1/300

KAстра BUDOWLANA

Rectangular mixing tub • Прямоугольная емкость для раствора
• Mörtelwanne • Vas pentru constructii

NUMER
KATALOGOWY



040 295

40 L

1/250

040 296

60 L

1/250

040 297

90 L

1/180



WIADRO BUDOWLANE

Builders bucket • Строительное ведро • Baueimer PE rund
• Galeata pentru zugravit



NUMER
KATALOGOWY



040 301

12 L

1/1000

040 302

16 L

1/450

040 303

20 L

1/600

040 304

5 L

1



motive
Jakość ma znaczenie



WIADRO BUDOWLANE NIEBIESKIE

Blue builders bucket • Ведро строительное синее • Baueimer blau
• Galeata pentru zurgavit

NUMER KATALOGOWY		
040 298	12 L	1
040 992	16 L	1
040 299	20 L	1



WIADRO OCYNKOWANE

Galvanized bucket • Ведро оцинкованное • Zinkeimer • Galeata zincata

NUMER KATALOGOWY		
040 271	10 L	1/20
040 272	12 L	1/20
040 273	15 L	1/20



WIADRO BIAŁE/POKRYWKA

White plastic bucket • Ведро белое/крышка • Farbeimer weiß • Galeata alba

NUMER KATALOGOWY			
040 293		5 L	1/25
040 294		10 L	1/500
040 993	pokrywka/lid	5 L	1/50
040 994	pokrywka/lid	10 L	1/50

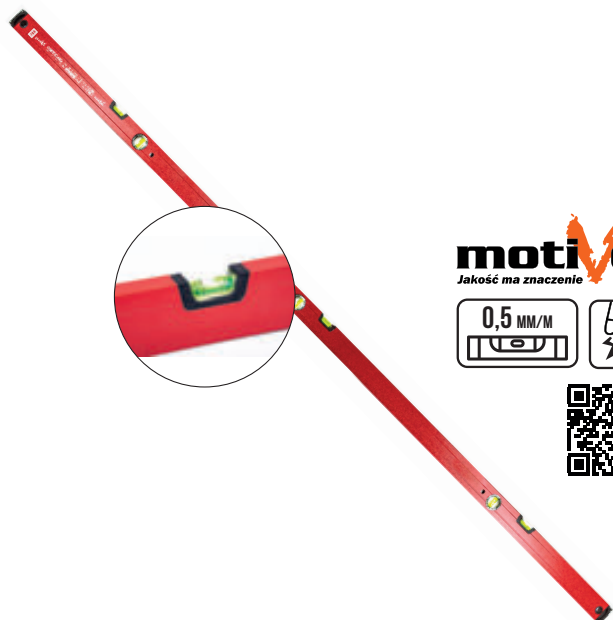

motive
Jakość ma znaczenie



POZIOMICA OPTICAL 6

Spirit level OPTICAL 6 • Уровень OPTICAL 6 • Wasserwaage OPTICAL 6
• Nivelă OPTICAL 6

NUMER KATALOGOWY		
040 887	200 cm	1/10



POZIOMICA HANDY HV

Spirit level HANDY HV • Уровень HANDY HV • Magnet Wasserwaage Handy HV
• Nivelă cu magnet

NUMER KATALOGOWY	↔	
040 890	23 cm	1/10

POZIOMICA SHARKY

Spirit level SHARKY • Уровень SHARKY • Wasserwaage für Fliesenleger Sharky
• Nivelă specială pentru construcții

NUMER KATALOGOWY	↔	
040 895	60 cm	1/10
040 896	100 cm	1/10

POZIOMICA HV

Spirit level HV • Уровень HV • Wasserwaage HV • Nivelă profesională

NUMER KATALOGOWY	↔	
040 880	40 cm	1/10/60
040 881	60 cm	1/10
040 882	80 cm	1/10/40
040 883	100 cm	1/10/40
040 884	120 cm	1/10/20
040 885	150 cm	1/10
040 886	200 cm	1/10

POZIOMICA HV Z MAGNESEM

Spirit level HV with magnet • Уровень HV • Magnet Wasserwaage HV
• Nivelă cu magnet

NUMER KATALOGOWY	↔	
040 873	40 cm	1/10/60
040 874	60 cm	1/10/60
040 875	80 cm	1/10/40
040 876	100 cm	1/10/40

POZIOMICA DRYWALL

Spirit level DRYWALL • Уровень DRYWALL • Trockenbau Wasserwaage
• Nivelă pentru pereti din gips-carton

NUMER KATALOGOWY	↔	
040 891	90 cm	1/10

motive
Jakość ma znaczenie



motive
Jakość ma znaczenie



motive
Jakość ma znaczenie



motive
Jakość ma znaczenie

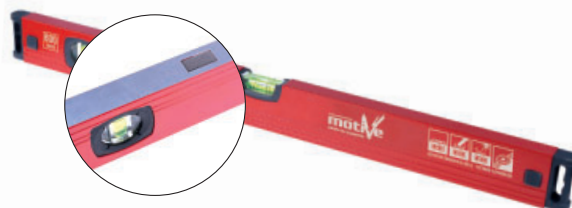

motive





motive
Jakość ma znaczenie



POZIOMICA PLUMBER

Spirit level PLUMBER • Уровень PLUMBER • Wasserwaage für den Installateur
• Nivelă pentru instalatori

NUMER KATALOGOWY	↔	
040 892	70 cm	1/10

motive
Jakość ma znaczenie



POZIOMICA ELECTRIC

Spirit level ELECTRIC • Уровень ELECTRIC • Elektriker-Wasserwaage
• Nivelă pentru electricieni

NUMER KATALOGOWY	↔	
040 893	48 cm	1/10
040 894	130 cm	1/10

motive
Jakość ma znaczenie



POZIOMICA RED

Spirit level RED • Уровень RED • Wasserwaage RED • Nivelă Red

NUMER KATALOGOWY	↔	
040 320	40 cm	1/10
040 321	60 cm	1/10
040 322	80 cm	1/10
040 323	100 cm	1/10
040 324	120 cm	1/10
040 325	150 cm	1/10
040 326	200 cm	1/10



motive
Jakość ma znaczenie

POKROWIEC NA POZIOMICIE

Spirit level carrying case • Сумка для уровней • Schoner für Wasserwaage

NUMER KATALOGOWY		
040 349	164 x 81 cm	1/25

* w sprzedaży pusty pokrowiec, bez poziomicy widocznych na zdjęciu



POZIOMICA PROFI MAGNES

Spirit level with magnet • Уровень PROFI MAGNES • Magnet Wasserwaage Profi
• Nivelă cu magnet

NUMER KATALOGOWY	↔	
040 305	40 cm	1/30
040 315	60 cm	1/30
040 316	80 cm	1/30
040 317	100 cm	1/30
040 318	120 cm	1/30
040 319	150 cm	1/30
040 308	200 cm	1/30



ŁATA MURARSKA TRAPEZOWA

Trapezium profile feather edge • Правило трапеция • Trapez Kartätsche
• Dreptar aluminiu, pentru constructii, tip trapez

NUMER KATALOGOWY	↔	
040 433	100 cm	1/5
040 434	120 cm	1/5
040 435	150 cm	1/5
040 436	180 cm	1/5
040 437	200 cm	1/5
040 438	240 cm	1/5

motive
Jakość ma znaczenie



ŁATA MURARSKA PION/POZIOM

Straight-edge aluminium profile V/H with vial • Правило с уровнем
• Alu-Richtlatte • Dreptar aluminiu, pentru constructii, cu 2 indicatori

NUMER KATALOGOWY	↔	
040 430	150 cm	1/5
040 431	200 cm	1/5
040 432	250 cm	1/5

motive
Jakość ma znaczenie

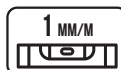

ŁATA MURARSKA TRAPEZOWA

Trapezium profile feather edge • Правило трапеция • Trapez Kartätsche
• Dreptar aluminiu, pentru constructii

NUMER KATALOGOWY	↔	
040 608	100 cm	1/10
040 609	120 cm	1/10
040 610	150 cm	1/10
040 611	180 cm	1/10
040 612	200 cm	1/10
040 613	240 cm	1/10
040 614	300 cm	1/10



ŁATA MURARSKA PION/POZIOM

Straight-edge aluminium profile V/H with vial • Правило с уровнем
• Alu-Richtlatte • Dreptar aluminiu, pentru constructii, cu 2 indicatori

NUMER KATALOGOWY	↔	
040 600	150 cm	1/10
040 601	200 cm	1/10
040 602	250 cm	1/10

ŁATA MURARSKA TYP H

H profile feather edge • Правило тип "h" • H-Profil-Kartätsche
• Dreptar aluminiu, pentru constructii, tip h

NUMER KATALOGOWY	↔	
040 618	150 cm	1/5
040 619	200 cm	1/5
040 620	250 cm	1/5





ŁATA MURARSKA Z UCHWYTEM

Aluminium profile V/H with handle • Правило с ручками • Alu Richtlatte mit 2 Handgriffe • Dreptar aluminiu, pentru constructii, cu 2 indicatori

NUMER KATALOGOWY	↔	
040 615	150 cm	1/10
040 616	200 cm	1/10
040 617	250 cm	1/10



POZIOMICA WODNA Z WĘŻEM

Water level • Уровень водный со шлангом • Schlauchwasserwaage • Furtun de nivel

NUMER KATALOGOWY		
040 307	20 m	1/10



KĄTOWNIK METALOWY

Metal angle ruler • Угломер металлический • Bauwinkel • Echer tamplarie

NUMER KATALOGOWY		
040 348	600 mm x 400 mm	1/6/36



NOŻYCE DO CIĘCIA BLACHY

Aviation Snips • Листовые ножницы • Blechscherer- links • Foarfeca de tabla, stanga

NUMER KATALOGOWY		
040 350	LEWE / LEFT	1/6/60



NOŻYCE DO CIĘCIA BLACHY

Aviation Snips • Листовые ножницы • Blechscherer- rechts • Foarfeca de tabla, dreapta

NUMER KATALOGOWY		
040 351	PRAWY / RIGHT	1/6/60



NOŻYCE DO CIĘCIA BLACHY

Aviation Snips • Листовые ножницы • Blechscheren- gerade
• Foarfeca de tabla

NUMER KATALOGOWY		
040 352	PROSTE / STRAIGHT	1/6/60

motive
Jakość ma znaczenie



PRZYRZĄD DO WIĄZANIA PRĘTÓW

Reinforcement rod tying tool • Инструмент для связывания арматуры
• Drillkurbel • Unealta pentru legat otel beton

NUMER KATALOGOWY	
040 368	1/12/48
040 367	TWIST WIRE 300 1/12/48

motive
Jakość ma znaczenie



motive
Jakość ma znaczenie



ŁAPKA DO GWOŹDZI

Crowbar • Гвоздодер • Brechstange • Ranga tip levier

NUMER KATALOGOWY			
040 358	19 mm	500 mm	1/20
040 359	19 mm	700 mm	1/20



PRZECINAK ZE STALI STOPOWEJ

Cold chisel with hand guard • Зубило закаленное • Flachmeissel mit Handschutz • Dalta pentru constructii, cu protectie

NUMER KATALOGOWY		
040 360	300 mm	1/6
040 361	400 mm	1/6



MŁOTEK CIESIELSKI MONOLIT

Roofing one-piece hammer, MONOLIT • Плотничный молоток MONOLIT
• Latthammer Monolit • Ciocan dulgheri

NUMER KATALOGOWY		
040 492	0.6 kg	1/3/6/24

motive
Jakość ma znaczenie





motive
Jakość ma znaczenie



MŁOTEK CIESIELSKI

Roofing, fiberglass handle hammer • Плотничный молоток
• Latthammer • Ciocan dulgheri

NUMER
KATALOGOWY

kg



040 491

0.6 kg

1/3/24



motive
Jakość ma znaczenie



MŁOTEK ŚLUSARKI

Machinist, fiberglass handle hammer • Слесарный молоток
• Schlosserhammer • Ciocan lacatus coada fibra

NUMER
KATALOGOWY

kg



040 481

0.1 kg

1/3/6/24

040 482

0.2 kg

1/3/6/24

040 483

0.3 kg

1/3/6/48

040 484

0.4 kg

1/3/6/36

040 485

0.5 kg

1/3/6/36

040 486

0.6 kg

1/3/6/36

040 487

0.8 kg

1/3/6/24

040 488

1 kg

1/3/6/24

040 489

1.5 kg

1/3/12

040 490

2 kg

1/3/6/12



MŁOTEK CIESIELSKI

Roofing hammer • Плотничный молоток • Latthammer • Ciocan dulgheri

NUMER
KATALOGOWY

kg



040 380

0.6 kg

1/6/24



motive
Jakość ma znaczenie



MŁOTEK STOLARSKI

Claw hammer • Столярный молоток • Klauenhammer • Ciocan tamplarie

NUMER
KATALOGOWY

kg



040 496

0.6 kg

1/6/24



MŁOTEK ŚLUSARSKI

Machinist hammer, wooden handle • Слесарный молоток
• Schlosserhammer • Ciocan pentru lacatus

NUMER
KATALOGOWY

kg



040 370

0.3 kg

1/6/60

040 374

0.4 kg

1/6/48

040 371

0.5 kg

1/6/36

040 375

0.8 kg

1/6/24

040 372

1.0 kg

1/6/24

040 373

1.5 kg

1/6/12

040 376

2.0 kg

1/6/12

040 377

3.0 kg

1/6



MŁOTEK MURARSKI MONOLIT

Masonry one-piece hammer MONOLIT • Молоток каменщика MONOLIT
• Maurerhammer • Ciocian zidarie

NUMER
KATALOGOWY

040 495



0.5 kg



1/3/6/24

motive
Jakość ma znaczenie



MŁOTEK STOLARSKI MONOLIT

Claw one-piece hammer MONOLIT • Столярный молоток MONOLIT
• Klauenhammer Monolit • Ciocan tamplarie Monolit

NUMER
KATALOGOWY

040 497



0.5 kg



1/3/6/24

motive
Jakość ma znaczenie



MŁOTEK GUMOWY UCHWYT METALOWY

Rubber head hammer, steel tube handle, rubber grip • Молоток резиновый
с металлической ручкой • Gummihammer mit Stahlrohrstiel und Gummigriff
• Ciocan cauciuc

NUMER
KATALOGOWY

040 390



0.45 kg



1/6/36



MŁOTEK MURARSKI

Masonry fiberglass handle hammer • Молоток каменщика • Maurerhammer
• Ciocian zidarie

NUMER
KATALOGOWY

040 494



0.6 kg



1/6/24

motive
Jakość ma znaczenie



MŁOTEK MURARSKI TYP BERLIŃSKI

Masonry hammer, wooden handle • Молоток каменщика тип "берлинский"
• Maurerhammer berliner form • Ciocian zidarie

NUMER
KATALOGOWY

040 385



0.7 kg



1/5





MŁOTEK GUMOWY UCHWYT DREWNIANY

Rubber head hammer, wooden handle • Молоток резиновый с деревянной ручкой • Gummihammer schwarz • Ciocan cauciuc negru maner lemn

NUMER KATALOGOWY	kg	
040 393	0.45 kg	1/6/24
040 391	0.6 kg	1/6/24
040 392	0.9 kg	1/6/24

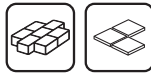

MŁOTEK GUMOWY BIAŁY

White rubber head hammer • Молоток резиновый белый • Gummihammer weiß • Ciocan cauciuc, alb

NUMER KATALOGOWY	kg	
040 394	0.5 kg	1/6/24
040 395	1 kg	1/6/24



TRZON DO MŁOTKA MURARSKIEGO

Shaft to hammer • Черенок для молотка • Maurerhammerstiel rheinische Form • Coada pentru ciocan

NUMER KATALOGOWY	
040 464	1/10



TRZON DO KILOFA

Shaft to pickaxe • Черенок для кирки • Stiel für Pickel • Coada pentru tarnacop

NUMER KATALOGOWY	kg	
040 480	2.5 kg	1/10



TRZON DO MŁOTKA

Shaft to hammer • Черенок для молотка • Hammerstiel • Coada pentru ciocan lacatus

NUMER KATALOGOWY		
040 450	28 cm	1/50
040 451	32 cm	1/50
040 452	36 cm	1/50
040 453	40 cm	1/50
040 454	50 cm	1/50
040 455	60 cm	1/10
040 456	70 cm	1/10
040 457	80 cm	1/10
040 458	90 cm	1/10

PĘDZLE I SZCZOTKI

КИСТИ И ЩЁТКИ • PAINTBRUSHES & BRUSHES

• PINSEL, BESEN • PENSULE, BIDINELE, MATURI





V-PRO

PROFESJONALNE PĘDZLE MALARSKIE

Seria nowoczesnych pędzli w pełnej gamie rozmiarowej gwarantujących najlepszy i najbardziej estetyczny efekt podczas malowania. Właściwie dopracowane włosie oraz wysokiej jakości wykończenie pędzli zadowolą nawet najbardziej wymagających użytkowników. Pędzle przeznaczone są do malowania wszystkimi rodzajami farb.



PĘDZLE
**V-PRO
AS**

Ścięte pod kątem włosie pomaga w precyzyjnym, końcowym malowaniu farbami wykończeniowymi. Idealne do malowania odcień kolorów.

Uniwersalne pędzle przydatne podczas większości prac malarskich. Do malowania drewna, metalu, ale również niedużych powierzchni ścian.

PĘDZLE
**V-PRO
SC**

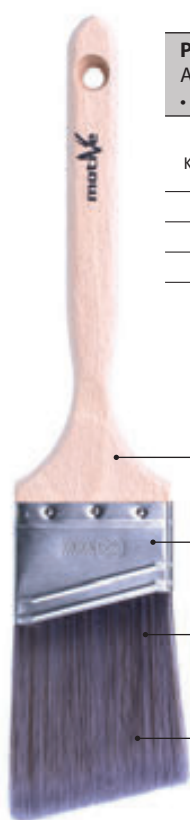

PĘDZEL V-PRO AS

Angled sash paintbrush AS
• Beschneidepinsel AS

NUMER KATALOGOWY			
050 571	66 mm	1,5"	1/12
050 572	70 mm	2"	1/12
050 573	80 mm	2,5"	1/12
050 574	85 mm	3"	1/12

PĘDZEL V-PRO SC

Paint brush SC • Malerpinsel SC

NUMER KATALOGOWY			
050 575	56 mm	1"	1/12
050 576	66 mm	1,5"	1/12
050 577	70 mm	2"	1/12
050 578	76 mm	2,5"	1/12
050 579	85 mm	3"	1/12
050 580	90 mm	3,5"	1/12



Lekka, wyprofilowana rączka wykonana ze szlifowanego, bukowego drewna

Matowa, metalowa i nierdzewna skuwka z wybitym na niej rozmiarem określającym szerokość pędzla

Gęste i hartowane włosie wykonane ze specjalistycznych okrągłych i zwężających się włókien

Użyty do osadzenia włosia klej epoksydowy zapobiega wypadaniu włókien podczas malowania



PĘDZEL V-PRO HANDY AS

Paint brush Handy AS • Malerpinsel Handy AS

NUMER KATALOGOWY			
050 565	70 mm	2"	1/12



PĘDZEL "WOOD"

Paintbrush „wood” • КИСТЬ WOOD • Flachpinsel Wood • Pensula plata Wood

NUMER KATALOGOWY			
050 060	51 mm	30 mm	1/12
050 061	58 mm	40 mm	1/12
050 062	60 mm	50 mm	1/12
050 063	65 mm	60 mm	1/12
050 064	70 mm	70 mm	1/12



PĘDZEL WINGER

Paintbrush WINGER • КИСТЬ WINGER • Malerpinsel Winger • Pensula Winger

NUMER KATALOGOWY			
050 051	68 mm	2.5"	1/12/240
050 052	73 mm	3"	1/12/240



PĘDZEL DO AKRYLI

Flat nylon paintbrush for acrylic paints • КИСТЬ для акриловых красок • Acrylpinsel • Pensula pentru vopsea pe baza de apa

NUMER KATALOGOWY			
050 550	56 mm	1"	1/12/600
050 551	57 mm	1.5"	1/12/600
050 552	58 mm	2"	1/12/360
050 553	71 mm	2.5"	1/12/300
050 554	70 mm	3"	1/12/240
050 555	80 mm	4"	1/12/120



PĘDZEL RED



Paintbrush RED, natural bristle, plastic handle • КИСТЬ RED • Flachpinsel Red • Pensula Red

NUMER KATALOGOWY			
050 070	45 mm	1"	12/360
050 071	53 mm	1.5"	12/360
050 072	56 mm	2"	12/300
050 073	64 mm	2.5"	12/240
050 074	67 mm	3"	12/120
050 075	80 mm	4"	12



PEŹZEL ANGIELSKI PROFI



Paintbrush, natural bristle, wooden, varnished handle • Кисть английская профи • Flachpinsel, lackierter Holzstiel • Pensula profi

NUMER KATALOGOWY			
050 510	45 mm	1"	1/15
050 511	46 mm	1.5"	1/15
050 512	47 mm	2"	1/15
050 513	52 mm	2.5"	1/15
050 514	50 mm	3"	1/15
050 515	56 mm	3.5"	1/15
050 516	58 mm	4"	1/15



PEŹZEL ANGIELSKI PROFI PLASTIK



Paintbrush, natural bristle, plastic, varnished handle • Кисть английская профи пластик • Flachpinsel, lackierter Kunststoff-Stiel • Pensula maner PVC

NUMER KATALOGOWY			
050 101	47 mm	1"	12/1200
050 102	47 mm	1.5"	12/720
050 103	51 mm	2"	12/360
050 104	52 mm	2.5"	12/360
050 105	50 mm	3"	12/240
050 106	60 mm	3.5"	12/240
050 107	60 mm	4"	12/180



PEŹZEL ANGIELSKI PLASTIK



Paintbrush, natural bristle, plastic handle • Кисть английская пластик • Flachpinsel, helle China-Borste • Pensula maner PVC

NUMER KATALOGOWY			
050 080	45 mm	25 mm	12/1200
050 081	47 mm	36 mm	12/600
050 082	51 mm	50 mm	12/480
050 083	51 mm	63 mm	12/360
050 084	51 mm	76 mm	12/240
050 087	58 mm	90 mm	12/240
050 085	57 mm	102 mm	12/240



PEŹZEL ANGIELSKI

Paintbrush, natural bristle, wooden handle • Кисть английская • Flachpinsel • Pensula plata

NUMER KATALOGOWY			
050 110	46 mm	25 mm	12/720
050 111	46 mm	36 mm	12/480
050 112	51 mm	50 mm	12/360
050 113	51 mm	63 mm	12/360
050 114	50 mm	76 mm	12/240
050 115	58 mm	90 mm	12/240
050 116	58 mm	102 mm	12/240





PEZDEL PÓLANGIELSKI

Paintbrush, natural bristle, flat wooden handle • Кисть полуанглийская
• Flachpinsel • Pensula plata

NUMER KATALOGOWY				
050 090	38 mm	25 mm	12/1200	
050 091	42 mm	36 mm	12/720	
050 092	43 mm	50 mm	12/480	
050 093	44 mm	63 mm	12/360	
050 094	45 mm	76 mm	12/360	
050 096	43 mm	90 mm	12/240	
050 095	52 mm	102 mm	12/240	



PEZDEL PŁASKI DO EMULSJI

Flat paintbrush for emulsion paints • Кисть плоская для эмульсий
• Flachpinsel für Dispersionsfarbe • Pensula plata

NUMER KATALOGOWY				
050 400	45 mm	1"	12	
050 401	46 mm	1.5"	12	
050 402	52 mm	2"	12	
050 403	51 mm	2.5"	12	
050 404	51 mm	3"	12	
050 405	52 mm	4"	12	



PEZDEL PŁASKI NYLON DO AKRYLI

Flat nylon paintbrush for acrylic paints • Кисть плоская «nylon» для акриловых красок • Acrylpinsel Nylon • Pensula pentru vopsea pe baza de apa

NUMER KATALOGOWY				
050 200	50 mm	1"	12	
050 201	58 mm	1.5"	12	
050 202	58 mm	2"	12	
050 203	65 mm	2.5"	12	
050 204	65 mm	3"	12	
050 206	77 mm	3.5"	12	
050 205	77 mm	4"	12	



PEZDEL OKRĄGŁY

Round paintbrush • Кисть круглая • Ringnpinsel • Pensula rotunda

NUMER KATALOGOWY				
050 130	34 mm	20 mm	12/1200	
050 131	34 mm	25 mm	12/960	
050 132	36 mm	30 mm	12/720	
050 133	42 mm	35 mm	12/576	
050 134	42 mm	40 mm	12/408	
050 135	41 mm	45 mm	12/336	
050 136	40 mm	50 mm	12/288	
050 137	46 mm	55 mm	12/240	
050 138	47 mm	60 mm	12/192	
050 139	48 mm	70 mm	12/144	



PĘDZEL OWALNO-PŁASKI

Paintbrush - OVAL shape • Кисть овально-плоская • Ovalpinsel • Pensulă ovala

NUMER KATALOGOWY			
050 182	51 mm	30 mm	12/600
050 183	51 mm	40 mm	12/480
050 184	51 mm	50 mm	12/480
050 185	50 mm	60 mm	12/240

PĘDZEL DO PASKÓW

Line flat brush • Кисть для полосок • Strichzieher • Pensula de linii

NUMER KATALOGOWY			
050 128	9 mm	2 mm	12
050 129	11 mm	4 mm	12
050 145	12 mm	6 mm	12
050 146	15 mm	8 mm	12
050 147	15 mm	10 mm	12
050 148	17 mm	12 mm	12
050 144	ZESTAW/SET	2,4,6 mm	1/12/240
050 149	ZESTAW/SET	8,10,12 mm	1/24/240

PĘDZEL V-PRO DO PASKÓW

Pointed sash brush • Schräg-Strichzieher • Кисть круглая • Pensula de linii

NUMER KATALOGOWY			
050 590	25 mm	6 mm	1/24/144
050 591	30 mm	12 mm	1/24/144
050 592	33 mm	18 mm	1/24/144

PĘDZEL V-PRO OKRĄGŁY

Lining fitch brush • Кисть для полосок • Sprossenpinsel • Pensula rotunda

NUMER KATALOGOWY			
050 595	52 mm	12 mm	12/72
050 596	52 mm	15 mm	12/72
050 597	53 mm	21 mm	12/72

PĘDZEL KALORYFEROWY V-PRO

Radiator paintbrush V-PRO • Радиаторная кисть V-PRO • Heizkörperpinsel V-PRO • Pensula pentru calorifer V-PRO

NUMER KATALOGOWY		
050 584	25 mm	10
050 585	35 mm	10
050 587	50 mm	12
050 588	70 mm	12



motive
Jakość ma znaczenie



motive
Jakość ma znaczenie



PĘDZEL
V-PRO
STRIPE

motive
Jakość ma znaczenie



PĘDZEL
V-PRO
ROUND

motive
Jakość ma znaczenie



PĘDZEL
V-PRO



motive
Jakość ma znaczenie



PĘDZEL KALORYFEROWY RED

Radiator paintbrush RED • Радиаторная кисть RED • Heizkörperpinsel Red
• Pensula pentru calorifer

NUMER KATALOGOWY			
050 190	46 mm	35 mm	12
050 191	55 mm	50 mm	12
050 192	54 mm	60 mm	6
050 193	56 mm	70 mm	6



PĘDZEL KALORYFEROWY

Radiator paintbrush • Радиаторная кисть • Heizkörperpinsel
• Pensula pentru calorifer

NUMER KATALOGOWY			
050 120	48 mm	25 mm	12/480
050 121	48 mm	36 mm	12/360
050 122	48 mm	50 mm	12/300
050 123	48 mm	63 mm	12/240

motive
Jakość ma znaczenie



PĘDZEL DO DEKORACJI

Mottler brush • Кисть для декора • Schleifmodler • Pensula pentru efecte decorative, tip spalter

NUMER KATALOGOWY			
050 186	48 mm	120 mm	1/12

motive
Jakość ma znaczenie



TAPETÓWKA

Block brush • Минимакловица • Flächenstreicher, helle Borste
• Bidinea pentru tapet

NUMER KATALOGOWY				
050 040	28 mm	58 mm	110 mm	1/5
050 041	28 mm	64 mm	130 mm	1/6
050 042	38 mm	68 mm	140 mm	1/6
050 043	49 mm	70 mm	150 mm	1/5



TAPETÓWKA

Block brush • Минимакловица • Flächenstreicher • Bidinea pentru tapet

NUMER KATALOGOWY				
050 150	22 mm	40 mm	70 mm	1/12/120
050 151	27 mm	45 mm	90 mm	1/12/120
050 152	27 mm	47 mm	110 mm	1/12/120
050 153	27 mm	45 mm	130 mm	1/12/120
050 154	31 mm	50 mm	140 mm	1/6/60
050 155	40 mm	50 mm	150 mm	1/6/60





ŁAWKOWIEC

Block brush • Макловица • Malerbürste • Bidinea pentru zugravit

NUMER KATALOGOWY				
050 160	55 mm	67 mm	170 mm	1/2/12
050 161	65 mm	67 mm	180 mm	1/2/12
050 162	74 mm	70 mm	190 mm	1/2/12

motive
Jakość ma znaczenie



CHLAPAK

Water splash brush • Кисть-брызгатель • Deckenbürste • Bidinea pentru grunduri

NUMER KATALOGOWY				
050 165	85 mm	65 mm	200 mm	1/50



CHLAPAK NYLON

Pasting brush • Кисть-брызгатель NYLON • Deckenbürste, Polypropylen-Borste • Bidinea pentru grunduri Nylon

NUMER KATALOGOWY			
050 163	65 mm	170 mm	1/40



SMOŁOWIEC SZARY

Tar brush grey • Макловица "серая" для нанесения холодных битумных масс • Teerbürste- grau • Bidinea pentru bituminoasa gri

NUMER KATALOGOWY			
050 170	70 mm	200 mm	1/60



SMOŁOWIEC SZARY KOMPLET

Tar brush grey, with pole • Макловица "серая" для нанесения холодных битумных масс, комплект • Teerbürste- grau, Satz • Bidinea pentru bituminoasa gri

NUMER KATALOGOWY			
050 159	70 mm	20 x 120 cm	1/40





KIJ DO SMOŁOWCA

Pole for tar brush • Черенок для "серой" или "белой" макловицы
• Holzstiel für Teerbürste • Coadă pentru bidinea bituminoasă

NUMER KATALOGOWY		
050 180	120 cm	1/25



ULICÓWKA

Street broom • Уличная щетка • Straßenbesen • Mătură stradă

NUMER KATALOGOWY			
050 175	75 mm	300 mm	1/10
050 176	85 mm	400 mm	1/10
050 177	85 mm	500 mm	1/10
050 178	75 mm	600 mm	1/10
050 179	80 mm	800 mm	1/10



KIJ DO ULICÓWKI

Pole for street broom • Черенок для уличной щетки • Besenstiel mit konus
• Coadă pentru mătură

NUMER KATALOGOWY			
050 181	23 mm	140 cm	1/25
050 142	23 mm	180 cm	1/25



ULICÓWKA ZE SKROBAKIEM METALOWYM

Street broom with metal scraper • Уличная щетка с ледорубом
• Straßenbesen mit Schabeblech • Mătură stradă

NUMER KATALOGOWY			
050 194	75 mm	440 mm	1/10



KIJ DO ULICÓWKI ZE SKROBAKIEM

Pole for street broom with metal scraper • Черенок для уличной щетки с ледорубом • Besenstiel • Coadă pentru mătură

NUMER KATALOGOWY			
050 195	28 mm	140 cm	1/25



SZCZOTKA DO KOSTKI BRUKOWEJ ZE SKROBAKIEM

Block paving brush with spike • Проволочная щетка для брусчатки со скребком • Pflasterstein-Besen • Perie pentru curatarea pavajului

NUMER
KATALOGOWY



050 196

1/10



ZAMIATACZ PRZEMYSŁOWY

Professional industrial broom • Метла "промышленная" • Industriebesen • Mătură industrială

NUMER
KATALOGOWY



050 600

65 mm

430 mm

1/10

050 601

65 mm

630 mm

1/10



ZAMIATACZ

Indoor broom head • Метла • Zimmerbesen • Matură interior

NUMER
KATALOGOWY



050 167

65 mm

380 mm

1/25



ZAMIATACZ PROFI

Indoor broom head Profi • Метла PROFI • Zimmerbesen Profi • Mătură profi

NUMER
KATALOGOWY



050 197

65 mm

320 mm

1/6



MIOTŁA

Nylon broom head • Метла • Allzweckbesen • Mătură

NUMER
KATALOGOWY



050 168

140 mm

350 mm

1/25





MIOTŁA NYLON

Nylon broom head • Метла "NYLON" • Allzweckbesen • Mătură Nylon

NUMER
KATALOGOWY



050 169

240 mm

1/25



MIOTŁA SKOŚNA

Slanting broom • Метла угловая • Allzweckbesen mit Stiel • Mătură oblică

NUMER
KATALOGOWY



050 173

270 mm

300 mm

150 cm

1/25



MIOTŁA SORGO

Corn broom • Broom „sorgo” style • Метла „Sorgo” • Reisstrohbesen
• Mătură Sorgo

NUMER
KATALOGOWY



050 172

450 mm

360 mm

140 cm

1/10

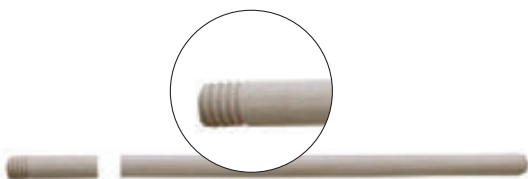

KIJ DO MIOTŁY I SMOŁOWCA GWINTOWANY

Threaded wooden pole • Черенок с резьбой • Besenstiel mit Gewinde
• Coadă pentru bidinea bituminoasă

NUMER
KATALOGOWY



050 164

120 cm

1/25

050 141

180 cm

1/25



ZMIOTKA

Sweeper • Метелка • Handfeger • Matura

NUMER
KATALOGOWY



050 166

170 mm

1/64



ZMIOTKA KOKOS

Hand brush coconut • Щетка КОКОС • Kokos-Handfeger • Matura de cocos

NUMER KATALOGOWY			
050 157	70 mm	160 mm	1



ZMIOTKA PROFI

Sweeper PROFI • Метелка PROFI • Handfeger Profi • Matura Profi

NUMER KATALOGOWY			
050 156	58 mm	150 mm	1/6/90



SZUFELKA ZE ZMIOTKĄ

Dustpan and sweeper set • Сок с щеткой • Schaufel mit Handfeger • Matura + faras

NUMER KATALOGOWY	
050 174	1/24



SZUFELKA METALOWA

Metal dustpan • Сок металлический • Handschaufel • Faras metalic

NUMER KATALOGOWY	
050 199	1/5



WYCIERACZKA SZCZOTKOWA

Shoe scrubber doormat • Придверный половик • Fußmatte mit Bürsten • Covoras de intrare cu perii

NUMER KATALOGOWY			
050 700	58 cm	37 cm	1





WYCIERACZKA SZCZOTKOWA BOCZNA

Shoe brush scrubber • Приспособление для чистки обуви • Schuhabtreter
• Perie pentru curatarea incaltamintei

NUMER
KATALOGOWY



050 701

36 cm

32 cm

1

ARTYKUŁY ŚCIERNE

АБРАЗИВЫ • ABRASIVE ARTICLES

• SCHLEIFZUBEHÖR • ABRAZIVE



ARTYKUŁY SZLIFIERSKIE

Artykuły szlifierskie Motive to wysokiej jakości produkty do obróbki ścierniej, które przeznaczone są do pracy z twardym materiałem. Charakteryzują się materiałem ściernym o różnej ziarnistości, pokrytym powłoką diamentową. Dzięki temu idealnie sprawdzają się przy usuwaniu niedoskonałości, zadziorów i końcowym szlifowaniu twardych materiałów takich jak płytki ceramiczne, gres, kamień lub powierzchnie betonowe.

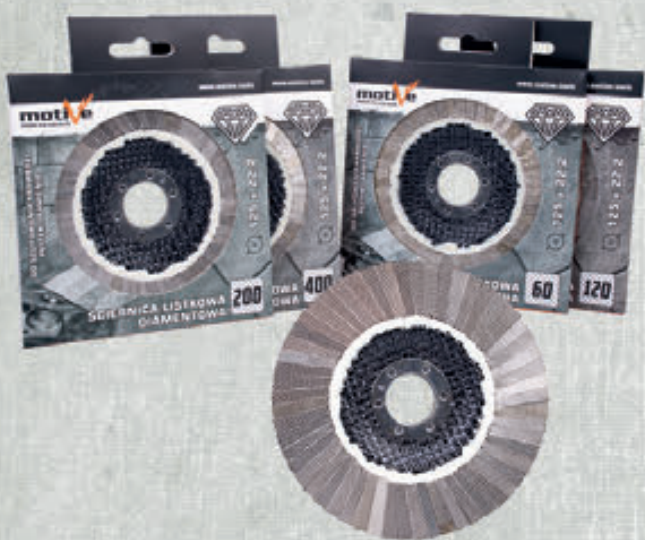



ŚCIERNICA LISTKOWA DIAMENTOWA

Profesjonalna ściernica przeznaczona do szlifowania płytek z ceramiki, kamienia naturalnego i gresu przy użyciu ręcznej szlifierki. Metalowe listki diamentowe pozwalają stawić czoła nawet najtwardszym materiałom, bez obaw o zmniejszenie właściwości ściernych.



ŚCIERNICA LISTKOWA DIAMENT

NUMER KATALOGOWY			
060 097	125 mm	60	1/10/100
060 098	125 mm	120	1/10/100
060 099	125 mm	200	1/10/100
060 100	125 mm	400	1/10/100



KOSTKA DO SZLIFOWANIA DIAMENTOWA

Poręczna gąbka do szlifowania pozwala w szybki sposób uporać się z ostrymi krawędziami płytek i gresu powstałymi po ich przycięciu dożądanego formatu. Możliwość pracy na sucho, jak również na mokro ułatwia obróbkę materiału bez obaw o jego uszkodzenie.



GĄBKĄ DO SZLIFOWANIA DIAMENTOWA

NUMER KATALOGOWY		
060 220	60	1/10/100
060 221	120	1/10/100
060 222	200	1/10/100
060 223	400	1/10/100



O SZCZEGÓŁY I DOSTĘPNOŚĆ
ZAPYTAJ HANDLOWCĄ W TWOIM REGIONIE

**PAPIER ŚCIERNY W ROLCE 50M**

Sandpaper roll • Наждачная бумага • Schleifpapier Rolle für Holz und Farben • Rola panza abraziva

NUMER KATALOGOWY				
	115 mm	50 m		
060 300	115 mm	50 m	40	1
060 301	115 mm	50 m	60	1
060 302	115 mm	50 m	80	1
060 303	115 mm	50 m	100	1
060 304	115 mm	50 m	120	1
060 305	115 mm	50 m	150	1
060 306	115 mm	50 m	180	1
060 307	115 mm	50 m	220	1
060 308	115 mm	50 m	240	1
060 309	115 mm	50 m	320	1

PAPIER ŚCIERNY W ROLCE 50M

Sandpaper roll • Наждачная бумага • Schleifpapier Rolle für Holz und Farben • Rola panza abraziva

NUMER KATALOGOWY				
	115 mm	50 m		
060 010	115 mm	50 m	40	1
060 011	115 mm	50 m	60	1
060 012	115 mm	50 m	80	1
060 013	115 mm	50 m	100	1
060 014	115 mm	50 m	120	1
060 015	115 mm	50 m	150	1
060 016	115 mm	50 m	180	1
060 017	115 mm	50 m	220	1
060 018	115 mm	50 m	240	1
060 019	115 mm	50 m	320	1

PAPIER ŚCIERNY W ROLCE 5M

Sandpaper roll • Наждачная бумага • Schleifpapier Rolle für Holz und Farben • Rola panza abraziva

NUMER KATALOGOWY				
	115 mm	5 m		
060 041	115 mm	5 m	40	1
060 042	115 mm	5 m	60	1
060 043	115 mm	5 m	80	1
060 044	115 mm	5 m	100	1
060 045	115 mm	5 m	120	1
060 046	115 mm	5 m	150	1
060 047	115 mm	5 m	180	1
060 048	115 mm	5 m	220	1

PŁÓTNO ŚCIERNE KLINGSPOR

Sanding cloth "KLINGSPOR" • Наждачное полотно "KLINGSPOR" • Schleifpapier KLINGSPOR • Coala abraziva Klingspor

NUMER KATALOGOWY				
			230 mm x 280 mm	
060 030	230 mm x 280 mm	40	50	
060 031	230 mm x 280 mm	60	50	
060 032	230 mm x 280 mm	80	50	
060 033	230 mm x 280 mm	100	50	
060 034	230 mm x 280 mm	120	50	
060 035	230 mm x 280 mm	150	50	
060 036	230 mm x 280 mm	180	50	
060 037	230 mm x 280 mm	220	50	
060 038	230 mm x 280 mm	240	50	

motive
Jakość ma znaczenie



**ZACIERACZKA**

Hand sander • Ручка для абразивной сетки • Handschleifer
• Suport smirghel cu surub fixare

NUMER
KATALOGOWY



060 179

100 mm x 230 mm

1/10/50

**ZACIERACZKA**

Hand sander • Ручка для абразивной сетки • Handschleifer
• Suport smirghel cu surub fixare

NUMER
KATALOGOWY



060 180

100 mm x 225 mm

1/10/50

**DYSK SZLIFIERSKI Z RZEPEM**

Sanding pad for grinder • Шлифовальный диск с липучкой • Klett Schleifteller
• Suport pt. disc abr. arici

NUMER
KATALOGOWY



060 050

125 mm

1/10/100

**DYSK DO WIERTAREK Z RZEPEM**

Sanding pad for drill • Шлифовальный диск к дрели с липучкой
• Klett Schleifteller für Bohrmaschine • Suport pt. disc velcro

NUMER
KATALOGOWY



060 051

125 mm

1/10/100

**KRAŻEK ŚCIERNY (RZEP) 10 SZT.**

Velcro sanding disc (10 pcs) • Наждачное полотно круглое с липучкой (10 шт.) • Klett Schleifscheiben (10 Stück) • Flansa abraziva pentru masina de slefuit, autoadeziva

NUMER
KATALOGOWY



060 053

125 mm

36

1/10/100

060 054

125 mm

40

1/10/100

060 055

125 mm

60

1/10/100

060 056

125 mm

80

1/10/100

060 057

125 mm

100

1/10/100

060 058

125 mm

120

1/10/100

060 059

125 mm

150

1/10/100

060 060

125 mm

180

1/10/100

060 061

125 mm

220

1/10/100

**ŚCIERNICA LISTKOWA DIAMENT**Diamond flap disc • Диск лепестковый выпуклый • Diamant Fächerscheibe
• Disc lamelar frontal diamant

NUMER KATALOGOWY			
060 097	125 mm	60	1/10/80
060 098	125 mm	120	1/10/80
060 099	125 mm	200	1/10/80
060 100	125 mm	400	1/10/80

motive
Jakość ma znaczenie
**ŚCIERNICA LISTKOWA WYPUKŁA**

Flap disc • Диск лепестковый выпуклый • Fächerscheibe • Disc lamelar frontal

NUMER KATALOGOWY			
060 090	125 mm	24	1/10/100
060 091	125 mm	36	1/10/100
060 092	125 mm	40	1/10/100
060 093	125 mm	60	1/10/100
060 094	125 mm	80	1/10/100
060 095	125 mm	100	1/10/100
060 096	125 mm	120	1/10/100

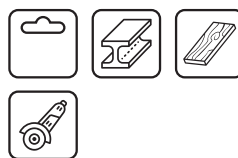
**KRAŻKI YELLOW PAD**

Velcro Yellow Pad • Шлифовальный диск "YELLOW PAD" • Klett-Schleifpapier perforiert • Hartie abraziva pentru masina de slefuit

NUMER KATALOGOWY			
060 210	225 mm	40	1/10/100
060 211	225 mm	60	1/10/100
060 212	225 mm	80	1/10/100
060 213	225 mm	100	1/10/100
060 214	225 mm	120	1/10/100
060 215	225 mm	150	1/10/100
060 216	225 mm	180	1/10/100
060 217	225 mm	220	1/10/100

motive
Jakość ma znaczenie
**KRAŻEK SUPERPAD**

Velcro superpad • Шлифовальный диск "SUPERPAD" • Klett-Schleifpapier perforiert • Hartie abraziva pentru masina de slefuit

NUMER KATALOGOWY			
060 069	225 mm	40	1/25
060 062	225 mm	60	1/25
060 063	225 mm	80	1/25
060 064	225 mm	100	1/25
060 065	225 mm	120	1/25
060 066	225 mm	150	1/25
060 067	225 mm	180	1/25
060 068	225 mm	220	1/25

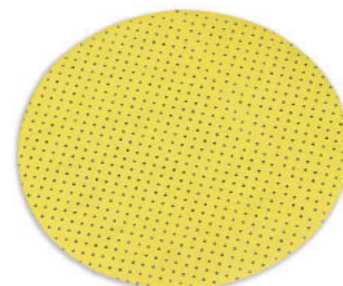



**WOOSTER®****TRÓJKĄT DO SZLIFOWANIA GŁADZI**

Aero Sander • Треугольник для шлифования гипса • Trockenbauschleifer

NUMER KATALOGOWY		
1801	9,5" (24 cm)	1/4

**WOOSTER®****PAPIER ŚCIERNY DO TRÓJKĄTA 6 SZT.**

Drywall sandpaper (6 pcs) • Наждачная бумага для треугольника для гипса (6 шт.) • Schleifscheiben für Aerosander 6 St.

NUMER KATALOGOWY			
1802	9,5" (24 cm)	80	1/10
1803	9,5" (24 cm)	120	1/10

**WOOSTER®****MOP DO CZYSZCZENIA GŁADZI**

Dust eater • Швабра для очистки гипса от пыли • Mopp Staubfresser

NUMER KATALOGOWY		
1800	16" (41 cm)	1/2



**WOOSTER®****ZAPAS DO MOPA DO CZYSZCZENIA GŁADZI**

Dust eater refill • Запаска для швабры для гипса • Ersatz für Staubfresser Mopp

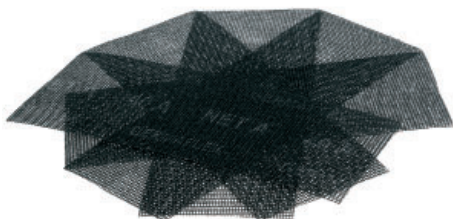
NUMER KATALOGOWY		
1805	16" (41 cm)	1/3



**SIATKA ŚCIERNA 5 SZT.**

Sanding mesh (5 pcs) • Абразивная сетка (5 шт.) • Schleifgitter (5 Stück) • Sita abraziva pentru suprafete gletuite

NUMER KATALOGOWY			
060 000	115 mm x 280 mm	40	1/10
060 001	115 mm x 280 mm	60	1/10
060 002	115 mm x 280 mm	80	1/10
060 003	115 mm x 280 mm	100	1/10
060 004	115 mm x 280 mm	120	1/10
060 005	115 mm x 280 mm	150	1/10
060 006	115 mm x 280 mm	180	1/10
060 007	115 mm x 280 mm	220	1/10

**GĄBKA DO SZLIFOWANIA**

Sanding sponge • Губка для шлифования • Schleifschwamm • Burete abraziv

NUMER KATALOGOWY		
060 181	40	1/250
060 182	60	1/250
060 183	80	1/250
060 184	100	1/250
060 185	120	1/250
060 186	150	1/250
060 187	180	1/250
060 188	220	1/250

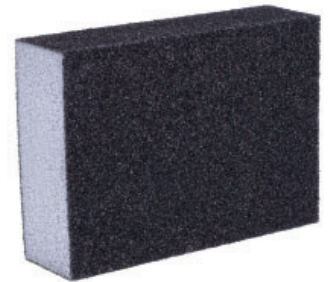

 motive
 Jakość ma znaczenie
**GĄBKA DO SZLIFOWANIA SKOŚNA**

Angled sanding sponge • Губка для шлифования остроугольная • Schleifschwamm schräg • Burete abraziv multifuncțional

NUMER KATALOGOWY		
060 190	60	1/100
060 191	80	1/100
060 192	100	1/100
060 193	120	1/100
060 194	150	1/100
060 195	180	1/100
060 196	220	1/100

 motive
 Jakość ma znaczenie
**GĄBKA DO SZLIFOWANIA DIAMENT**

Diamond sanding sponge • Губка для шлифования • Diamant-Schleifschwamm • Burete abraziv diamant

NUMER KATALOGOWY		
060 220	60	1/10/100
060 221	120	1/10/100
060 222	200	1/10/100
060 223	400	1/10/100

 motive
 Jakość ma znaczenie
**STRUG (FAZOWNIK) DO PŁYT GIPS-KARTON**

Plasteboard planner • Рубанок кромочный для гипсокартона • Hobel für Gipskartonplatten • Rindea pentru gips carton

NUMER KATALOGOWY	
060 176	1/48

 motive
 Jakość ma znaczenie



motive
Jakość ma znaczenie

OSTRZA DO (FAZOWNIKA) STRUGA PŁYT G-K
Plasterboard planner blades • Лезвия для рубанка кромочного
• Ersatzmesser für Kantenhobel • Rezerve lame rindea pt gips-carton

NUMER
KATALOGOWY



060 177

x3

x3

1/200



motive
Jakość ma znaczenie



TARNIK TYP BLOK
Surform block plane • Шлифованный брусок • Blockhobel
• Razuitoare gips-carton

NUMER
KATALOGOWY



060 169

140 mm

1/10/50

060 170

250 mm

1/5/50



OSTRZE DO TARNIKA
Surform refill blade • Лезвие для шлифовального бруска
• Ersatzblatt für Blockhobel • Rezerva rindea pentru gips carton

NUMER
KATALOGOWY



060 171

250 mm

1/60

060 172

140 mm

1/120



CYKLINA
Floor scraper • Цикля • Ziehklinge amerikanische Form • Răzuitor

NUMER
KATALOGOWY



060 140

40 mm x 190 mm

1/75

060 141

60 mm x 200 mm

1/50



motive
Jakość ma znaczenie



SZCZOTKA DOCZOŁOWA DF Z NAKRĘTKĄ M14
Waved wire cup brush with M14 thread • Щетка крацовка нас. с гайкой M14, из
витой проволоки • Topfbürste, Stahl, gewellter Draht M14 • Perie sarma cupa

NUMER
KATALOGOWY



max
R.P.M.



090 500

60 mm

12500

1/10/100

090 501

80 mm

12500

1/10/100

090 502

100 mm

8500

1/4/40

090 503

125 mm



6500

1/4/24





SZCZOTKA DOCZOŁOWA DF-TRZPIEŃ 6 mm

Waved wire cup brush with 6 mm shank • Щетка крацовка со стержнем, из витой проволоки 6 мм • Topfbürste gewellt für Bohrmaschinen, 6 mm Schaft • Perie sarma cupa

NUMER KATALOGOWY		max R.P.M.	
090 504	50 mm	4500	1/10/200
090 505	63 mm	4500	1/10/120
090 506	75 mm	4500	1/10/120

SZCZOTKA DOCZOŁOWA DS Z NAKRĘTKĄ M14

Twisted wire cup brush with M14 thread • Щетка крацовка с гайкой M14/со скрученной проволоки • Topfbürste, Stahl, gezopfter Draht M14 • Perie sarma cupa M14

NUMER KATALOGOWY		max R.P.M.	
090 507	65 mm	12500	1/10/100
090 508	80 mm	12500	1/10/100
090 509	100 mm	8500	1/4/40
090 510	125 mm	6500	1/24



SZCZOTKA DOCZOŁOWA DS - TRZPIEŃ 6 mm

Twisted wire cup brush with 6 mm shank • Щетка крацовка со стержнем, со скрученной проволоки 6 мм • Topfbürste gezopft für Bohrmaschinen, 6 mm Schaft • Perie sarma cupa

NUMER KATALOGOWY		max R.P.M.	
090 511	65 mm	12500	1/10/120



SZCZOTKA DOCZOŁOWA DF STOŻKOWA M14

Waved wire bevel brush with M14 thread • Щетка конусная с гайкой M14, из витой проволоки • Kegelbürste, gewellter Draht M14 • Perie sarma rotunda M14

NUMER KATALOGOWY		max R.P.M.	
090 513	100 mm	12500	1/10/100
090 514	115 mm	12500	1/10/60
090 515	125 mm	12500	1/10/60



SZCZOTKA DOCZOŁOWA DS STOŻKOWA M14

Twisted wire bevel brush with M14 thread • Щетка конусная с гайкой M14, из витой проволоки • Kegelbürste, gezopfter Draht M14 • Perie sarma rotunda M14

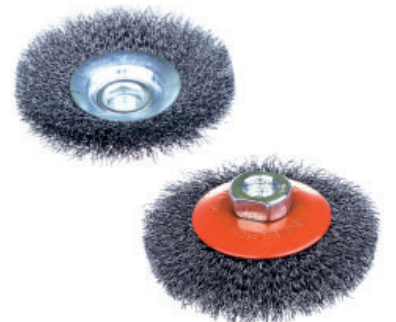

NUMER KATALOGOWY		max R.P.M.	
090 516	100 mm	12500	1/10/100
090 517	115 mm	12500	1/60



**SZCZOTKA TARCZOWA DRUT SKRĘCANY**Twisted wire circular brush • Щетка дисковая, со скрученной проволоки
• Scheibenbürste für Winkelschleifer • Perie sarma rotunda



NUMER KATALOGOWY		max R.P.M.	
090 520	100 mm	11 000	1/12/120
090 521	115 mm	11 000	1/6/60
090 522	125 mm	11 000	1/6/60

**SZCZOTKA TARCZOWA DRUT FALOWANY**Waved wire circular brush • Щетка дисковая, из витой проволоки
• Scheibenbürste für Winkelschleifer • Perie sarma rotunda



NUMER KATALOGOWY		max R.P.M.	
090 523	100 mm	4 500	1/12/120
090 524	115 mm	4 500	1/10/60
090 525	125 mm	4 500	1/6/60

**SZCZOTKA TARCZOWA DRUT FALOWANY, TRZPIEŃ**

Waved wire circular brush with shaft • Щетка дисковая со стержнем, из витой проволоки • Scheibenbürste • Perie sarma rotunda

NUMER KATALOGOWY		max R.P.M.	
090 526	80 mm	4 500	1/20/120
090 527	100 mm	4 500	1/14/84

**motive**
Jakość ma znaczenie**SZCZOTKA DRUCIANA SOFT**Wire brush with soft grip handle • Проволочная щетка "SOFT"
• Drahtbürste mit Schaber Soft • Perie sarma Soft

NUMER KATALOGOWY			
090 116	300 mm	4-rzędowa/4 rows	1/10/60



**SZCZOTKA DRUCIANA UCHWYT PLASTIKOWY**

Wire brush, plastic handle • Проволочная щетка пласт. • Stahldrahtbürste "vermessingt" • Perie sarma maner plastic



NUMER KATALOGOWY		
090 115	240 mm	1/12/120

**SZCZOTKA DRUCIANA**

Wire brush, wooden handle • Проволочная щетка • Drahtbürste • Perie sarma

NUMER KATALOGOWY		
090 110	4-rzędowa/4 rows	1/12/120
090 111	5-rzędowa/5 rows	1/12/120
090 112	6-rzędowa/6 rows	1/12/120

**SZCZOTKA DRUCIANA PROFI**Wire brush PROFI, wooden handle • Проволочная щетка ПРОФИ
• Drahtbürste Profi • Perie sarma Profi

NUMER KATALOGOWY		
090 113	4-rzędowa/4 rows	1/50
090 114	5-rzędowa/5 rows	1/50



ARTYKUŁY GLAZURNICZE I NARZĘDZIA DO TAPETOWANIA

ИНСТРУМЕНТ ДЛЯ ОБЛИЦОВОЧНЫХ РАБОТ И НАКЛЕЕВАНИЯ ОБОЕВ • TILING ACCESSORIES AND WALLPAPERING TOOLS
• FLIESEN- UND TAPETIERZUBEHÖR • SCULE MONTAJ PLACI CERAMICE



PODNOŚNIK - WSPORNIK GLAZURNICZY

WIELOZADANIOWY POMOCNIK



MAX
105 kg

Spust
zwalniający

Mechanizm do podnoszenia i regulacji wysokości

Trzy sztywne pręty stabilizujące

Stabilna podstawa z lakierowanej proszkowo blachy

zakres pracy od 1 cm do 40,5 cm

Nr kat. 070 060

PISTOLET DO PODNOSZENIA PŁYTEK I NIE TYLKO. Ten prosty i sprytny przyrząd znajdzie zastosowanie nie tylko w pracach glazurniczych, ale również w wielu pracach monterskich, stolarskich i okołodomowych. Po ustawieniu właściwej pozycji (wysokości) pistolet posłużyć może jako stabilna podpora i przymiar przy klejeniu płytek wielkoformatowych lub płyt typu beton architektoniczny. Ułatwia też ustawienie i wy poziomowanie na ścianie płyt gipsowo-kartonowych. Może być przydatny również do ustabilizowania pralki, wy poziomowania bramy, czy ustawienia elementów przed ich skrceniem. Zakres pracy wspornika wynosi od 1 cm do nieco ponad 40 cm.

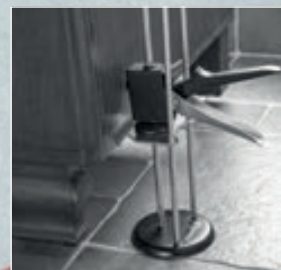



PISTOLET DO PODNOSZENIA PŁYTEK

Tile lifter • Устройство для поднятия и выравнивания плитки • Fliesen-und Plattenheber • Unealta manuala pentru pozitionare nivelare placi ceramic

NUMER
KATALOGOWY



070 060

105 kg

1 - 40,5 cm

1

motive
Jakość ma znaczenie



SYSTEM POZIOMOWANIA PŁYTEK WIELOKROTNEGO UŻYTKU

Reusable tile leveling system • Система за изравняване на плочки за многократна употреба • Wiederverwendbar Fliesen Nivelliersystem • Sistem reglabil, reutilizabil de nivelare a plăcilor

NUMER
KATALOGOWY



070 089

50 szt.

1,5 mm

16 mm

1/25

motive
Jakość ma znaczenie



KLIPSY DO POZIOMOWANIA PŁYTEK

Tile leveling clips • Клипсы для выравнивания плиток • Zuglaschen • Distantiere pentru gresie si faianta

NUMER
KATALOGOWY



Do płytek o grubości do 12 mm

070 081

30 szt.

1 mm

1/10/40

070 073

30 szt.

1,5 mm

1/10/40

070 083

30 szt.

2 mm

1/10/40

070 078

100 szt.

1 mm

1/10/40

070 074

100 szt.

1,5 mm

1/10/40

070 079

100 szt.

2 mm

1/10/40

070 087

100 szt.

3 mm

1/10/40

Do płytek o grubości od 12 mm do 20 mm

070 085

100 szt.

2 mm

1/10

motive
Jakość ma znaczenie



KLINY DO POZIOMOWANIA PŁYTEK

Leveling clips • Клинья для выравнивания плиток • Fliesen Nivelliersystem-Keile • Pene nivelare placi ceramic

NUMER
KATALOGOWY



070 077

100 szt.

1/10/40

motive
Jakość ma znaczenie



KLINY + KLIPSY DO POZIOMOWANIA PŁYTEK - 30 KPL

Tile leveling wedges & clips, 30 pcs • Клинья и клипсы для выравнивания плиток (30 компл.) • Nivelliersystem- Laschen und Keile (30 Stücke) • Sistem de nivelare gresie si faianta (30 buc)

NUMER
KATALOGOWY



070 080

30 szt.

30 szt.

1 mm

1/10/20

070 082

30 szt.

30 szt.

2 mm

1/10/20

motive
Jakość ma znaczenie





motive
Jakość ma znaczenie



SZCZYPCE DO SYSTEMU POZIOMOWANIA PŁYTEK

Tile leveling plier • Щипцы для системы выравнивания плиток • Zange für Bodenverlegung • Cleste pentru distantiere autonivelante

NUMER
KATALOGOWY

070 086



1/6/24



motive
Jakość ma znaczenie



ZESTAW DO POZIOMOWANIA PŁYTEK

Tile leveling system • Комплект для системы выравнивания плиток • Fliesen Nivelliersystem • Sistem de nivelare gresie si faianta clips, pene

NUMER
KATALOGOWY

070 088



1 szt.



100 szt.



100 szt.



1



KLIPSY DO POZIOMOWANIA PŁYTEK 30 KPL

Tile leveling clips, 30 pcs • Клипсы для выравнивания плиток (30 шт.) • Zuglaschen (30 Stücke) • Distantiere pentru gresie si faianta (30 buc)

NUMER
KATALOGOWY

070 118



30 szt.



30 szt.



1,3 mm



1/50



KLINY I KLIPSY DO POZIOMOWANIA PŁYTEK 30 KPL

Tile leveling wedges & clips, 30 sets • Клинья и клипсы для выравнивания плиток (30 компл.) • Nivelliersystem- 30 Stücke Laschen und Keile • Sistem de nivelare gresie si faianta

NUMER
KATALOGOWY

070 117



30 szt.



30 szt.



1,3 mm



1/50



KLINY MONTAŻOWE

Plastic wedges, 30 sets • Монтажные клинья • Montagekeile • Set pene distantiere montaj parchet, parchet laminat, PVC

NUMER
KATALOGOWY

070 071



10 szt.



90 x 43 x 13 mm



1/50

070 070

50 szt.

90 x 43 x 13 mm

1/50



KOMPLET GLAZURNICZY

Tiling set • Набор для облицовочных работ • Fliesenlegerset
• Set pentru curatat gresie & faianta

NUMER KATALOGOWY		
070 170	24 l	1

motive
Jakość ma znaczenie



WIADRO GLAZURNICZE Z ROLKAMI

Grout cleaning bucket • Ведро для облицовочных работ с роликами
• Fliesenwaschset • Galeata pentru curatat gresie & faianta

NUMER KATALOGOWY		
070 171	24 l	1/20

motive
Jakość ma znaczenie



KÓŁKA DO WIADRA GLAZURNICZEGO 4szt.

Wheels for grout cleaning bucket • Колесики к ведру для облицовочных работ
• Rädchen für Fliesen-Wascheimer • Roti pentru galeata gresie

NUMER KATALOGOWY	
070 175	1



ROLKI DO WIADRA GLAZURNICZEGO

Spare rollers for grout cleaning bucket • Ролики для ведра для облицовочных работ
• Rollenaufsatz für wascheimer • Role de stoarcere

NUMER KATALOGOWY	
070 172	1/40



KRZYŻYKI DYSTANSOWE Z UCHWYTEM

Tile spacers with a holder • Крестики для плитки с держателем
• Fliesenkreuze mit Griff • Distantiere pentru gresie si faianta

NUMER KATALOGOWY			
070 090	100 szt.	1,5 mm	1/50
070 091	70 szt.	2 mm	1/50
070 092	70 szt.	2,5 mm	1/50
070 093	70 szt.	3 mm	1/50
070 094	70 szt.	4 mm	1/50
070 095	60 szt.	5 mm	1/50

motive
Jakość ma znaczenie







motive
Jakość ma znaczenie

KRZYŻYKI DYSTANSOWE

Tile spacers • Крестики для плитки • Fliesenkreuze
• Distanțiere pentru gresie și faianța



NUMER KATALOGOWY			
070 100	150 szt.	1 mm	1/50
070 101	150 szt.	1,5 mm	1/50
070 102	150 szt.	2 mm	1/50
070 103	150 szt.	2,5 mm	1/50
070 104	150 szt.	3 mm	1/50
070 105	100 szt.	3,5 mm	1/50
070 106	100 szt.	4 mm	1/50
070 107	75 szt.	5 mm	1/50
070 108	50 szt.	6 mm	1/50
070 109	30 szt.	8 mm	1/50
070 110	30 szt.	10 mm	1/50



motive
Jakość ma znaczenie

T DO PŁYTEK KLINKIEROWYCH

Clinker brick crosses • Крестики "Т" для плитки • Fliesen T-Stücke
• Distanțiere pentru gresie și faianța T

NUMER KATALOGOWY			
070 111	50 szt.	6 mm	1/50
070 112	30 szt.	8 mm	1/50
070 113	30 szt.	10 mm	1/50



motive
Jakość ma znaczenie

KLINY TYP C

Tile spacers C-type • Клинья для выравнивания плитки тип „С”
• Fliesenkeile C-Form • Pene distanțiere pentru gresie tip C



NUMER KATALOGOWY			
070 114	50 szt.	1-12 mm	1/10/100



motive
Jakość ma znaczenie

KLINY



Tile wedges • Клинья для плитки • Fliesenkeile • Pana pentru faianța

NUMER KATALOGOWY			
070 115	100 szt.	male / small	1/50
070 116	30 szt.	duże / large	1/50



FUGOWNICA

Grout spreader • Шпатель резиновый для швов • Fugengummi mit Holzgriff
• Spaclu cauciuc

NUMER KATALOGOWY		
070 130	150 mm	1/10/50
070 131	200 mm	1/10/50
070 132	250 mm	1/10/50



GĄBKA HYDRO

Grout sponge Hydro • Губка для облицовочной плитки HYDRO
• Hydroschwamm • Burete Hidro

NUMER KATALOGOWY			
070 126	70 mm	135 x 105 mm	1/50

motive
Jakość ma znaczenie



GĄBKA SYNTETYK DO GLAZURY

Grout sponge • Губка для облицовочной плитки SYNTETYK
• Fliesenschwamm Synthetisch • Burete absorbant

NUMER KATALOGOWY			
070 169	70 mm	230 x 120 mm	1/5



GĄBKA DO GLAZURY

Grout sponge • Губка для облицовочной плитки • Fliesenschwamm
• Burete universal

NUMER KATALOGOWY			
070 135	70 mm	140 x 110 mm	1/10



GĄBKA DO FUG EPOKSYDOWYCH

Epoxy grout tile sponge • Глазуванная губка • Epoxid Fliesenschwamm
• Burete celuloza Epoxi

NUMER KATALOGOWY			
070 127	54 mm	185 x 110 mm	1/100

motive
Jakość ma znaczenie



GĄBKA Z GUMĄ

Grout sponge with rubber • Губка с резиной • Fliesenschwamm mit dem Gummi • Burete universal

NUMER KATALOGOWY			
070 136	70 mm	140 x 110 mm	1/30





PACA DO SPOINOWANIA

Epoxy grout float • Терка для фуговки • Fugenbrett • Drisca cauciuc dur

NUMER
KATALOGOWY



070 137

16 mm

240 x 100 mm

1/12/36



motive
Jakość ma znaczenie

PACA DO FUGOWANIA Z GUMĄ ŚCIĘTĄ

Grout float • Резиновая терка для фуговки • Fugenbrett für Fliesen • Gletiera cauciuc

NUMER
KATALOGOWY



070 138

250 x 90 mm

1/30



ZAPAS GUMOWY DO PACY FUGOWEJ

Grout float refill • Запаска резиновая для терки для фуговки • Ersatzbelag für Fugenbrett • Rezerva pentru gletiera cauciuc

NUMER
KATALOGOWY



070 129

16 mm

250 x 100 mm

1/10



PACA Z WŁÓKNINĄ

Scrub float with pads • Терка с тканью • Pad-Handbrett für Exporxidverfugungen • Gletiera curatat gresie

NUMER
KATALOGOWY



070 166

130 x 270 mm

1/10



WŁÓKNINA BIAŁA

Replacement pad- white for polishing • Ткань белая (мягкая для полеровки) • Vliesauflage weiss (fein) • Rezerva abraziva, alba

NUMER
KATALOGOWY



070 167

biała / white

1/10



WŁÓKNINA CZARNA

Replacement pad- black for cleaning • Ткань черная (грубая для чистки)
• Vliesauflage schwarz (grob) • Rezerva abraziva, negru

NUMER
KATALOGOWY



070 168

czarna / black

1/10



WOLFRAMOWY SKROBAK DO FUG

Tungsten grout rake • Вольфрамовая брусочка для швов
• Fugenreiniger Hartmetall • Razuitoare placi ceramice

NUMER
KATALOGOWY



070 164

1/10/100



SKROBAK DO FUG

Sealant remover • Брусочка для швов • Fugenkratzer
• Razuitoare placi ceramice

NUMER
KATALOGOWY



070 165

1/10/100



LISTWA DO KLINKIERU

Brick wall spacer • Планка выравнивающая для плитки • Leiste für Klinker
• Profil de distantiere pentru clincher

NUMER
KATALOGOWY



070 144

0,8 x 1,0 x 200 cm

50

040 154

1,0 x 1,0 x 200 cm

50

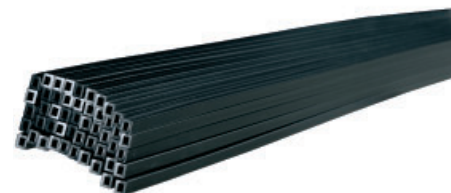

MASZYNA DO GLAZURY

Tile cutter • Плиткорез ручной • Fliesenschneider • Masina de taiat faianta

NUMER
KATALOGOWY



070 140

300 mm

1/10

070 139

400 mm

1/10

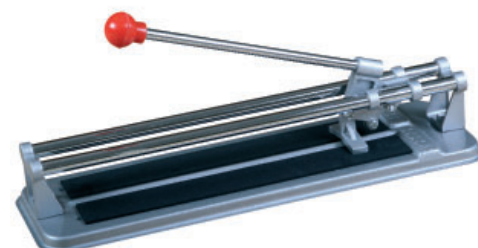

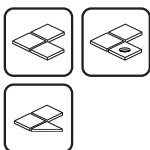

MASZYŃKA DO GLAZURY 3 FUNKCYJNA

Tile cutter with tile hole cutter • Плиткорез ручной 3 функции
• Fliesenschneider • Masina de taiat faianta, cu 3 functii

NUMER KATALOGOWY	↔	
070 141	480 mm	1/4



MASZYŃKA DO GLAZURY PROFI

Tile cutting machine PROFI • Плиткорез ручной "PROFI"
• Fliesenschneider Profi • Masina de taiat faianta

NUMER KATALOGOWY	↔	
070 142	600 mm	1/4



KÓŁKO WYMIENNE ZE ŚRUBĄ

Tile cutter wheel • Запасной ролик с винтом для плиткореза
• Ersatz Schneidrad • Rola schimb

NUMER KATALOGOWY		
070 150	15 mm	1/100
070 151	16 mm	1/100
070 152	22 mm	1/100



RYSIK DO GLAZURY

Etching pen • Карандаш для плитки • Reißnadel • Ac de trasat

NUMER KATALOGOWY	↔	
070 148	140 mm	1/50/500



OTWORNICA DO GLAZURY

Hole cutter • Сверло для облицовочной плитки • Fliesenlochbohrer
• Burghiu pentru gresie

NUMER KATALOGOWY		
070 145	30 - 110 mm	1/12



PRZYRZĄD DO UKŁADANIA GLAZURY

Tile leveling set • Инструмент для облицовочных работ • Fliesenlegerecken
• Dispozitiv aliniere gresie & faianta

NUMER KATALOGOWY		
070 120	45 x 40 mm	1/60



UCHWYTY MAGNETYCZNE DO GLAZURY

Tiled magnetic catches • Магнитный замок для облицовочных плиток
• Fliesenmagnet Satz • Set magneti pentru usa de vizitare din faianta

NUMER KATALOGOWY		
070 125		1/100



WYKROJNIK

Profile contour gauge • Шаблон для плитки • Konturenlehre
• Sablon masurare profil

NUMER KATALOGOWY		
070 121	250 mm	1/10/40



SZABLON DO KSZTAŁTÓW

Multi angle template tool • Универсальная шестистворчатая линейка, регулируемая • Winkelschablone • Rigla sablon multi-unghi

NUMER KATALOGOWY		
070 123	26, 41, 46 mm	1/10/40



ROLKA DO TAPET

Wallpaper press on roller • Валик для обоев • Nahtroller • Trafalet pentru tapet

NUMER KATALOGOWY		
070 220	5 cm	1/50
070 221	15 cm	1/40

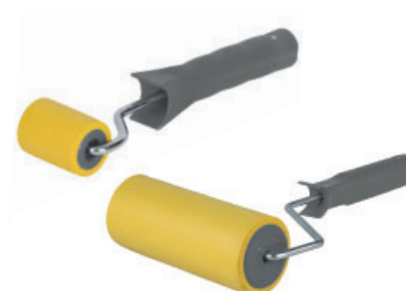



motive
Jakość ma znaczenie

SZPACHELKA DO TAPET

Wallpaper smoother • Шпатель обойный • Tapezierspachtel
• Spatula pentru montajul tapetului

NUMER
KATALOGOWY



070 301

17 x 27 cm

1/50



motive
Jakość ma znaczenie

NÓŻ POCKET

Folding utility knife POCKET • Нож POCKET • Klappmesser mit Trapezklinge
POCKET • Cutter universal



NUMER
KATALOGOWY



070 196

x3

1/12/48



motive
Jakość ma znaczenie

NÓŻ SECURO

Knife cutter SECURO • Нож SECURO • Messer SECURO
• Cutter universal



NUMER
KATALOGOWY



070 197

x1

1/12/24



motive
Jakość ma znaczenie

NÓŻ 2BLADES

Knife cutter 2BLADES • Нож 2BLADES • Messer mit zwei Klingen
• Cutter multifunctional cu 2 lame



NUMER
KATALOGOWY



070 181

x2

x2

1/12/48



motive
Jakość ma znaczenie

NÓŻ AUTOMATYCZNY

Self-loading cutter • Нож с автоматической сменой лезвий
• Abbrechmesser mit automatischer Nachladung • Cutter universal



NUMER
KATALOGOWY



070 187

x5



18 mm

1/6/72



NÓZ PUSH-LOCK

Cutter Push-Lock • Нож Push-Lock • Messer PUSH-LOCK • Cutter universal

NUMER KATALOGOWY			
070 182	x1	18 mm	1/12/144

motive
Jakość ma znaczenie



NÓZ DO KARTONU

Box cutter • Нож для картонных коробок • Saugus peilis • Kartonmesser

NUMER KATALOGOWY		
070 183	x4	1/12/72

motive
Jakość ma znaczenie



NÓZ HAKOWY

Hook blade cutter • Нож с лезвием крюком • Hakenmesser • Cutter multifunctional cu lame carlig



NUMER KATALOGOWY		
070 189	x3	1/6/72

motive
Jakość ma znaczenie



NÓZ Z OSTRZEM ŁAMANYM

Cutter, soft handle • Строительный нож • Abbrechmesser für Abbrechklingen • Cutter universal



NUMER KATALOGOWY			
070 207	x1	25 mm	1/12/120
070 208	x1	18 mm	1/12/48

motive
Jakość ma znaczenie



NÓZ ŁAMANY PROFI

Cutter, soft handle PROFI • Строительный нож "PROFI" • Profi-Abbrechklingen-Messer • Cutter universal + 5 lame

NUMER KATALOGOWY			
070 190	x 5	18 mm	1/12/72

motive
Jakość ma znaczenie





NÓŻ DO WYKŁADZIN

Carpet cutter • Нож для ковровых покрытий • Teppichschneider
• Cutter pentru mocheta

NUMER
KATALOGOWY

070 195



x1



8/80



NÓŻ INTERLOCK

Snap off cutter "INTERLOCK" • Нож "INTERLOCK" • Interlock Messer
• Cutter Interlock

NUMER
KATALOGOWY

070 201



x1



18 mm



1/12/144



NÓŻ ŁAMANY

Snap off cutter • Строительный нож • Universalmesser Kunststoff
• Cutter universal

NUMER
KATALOGOWY

070 202



x1



18 mm



1/25/250



NÓŻ ŁAMANY ABS

Snap off cutter ABS • Строительный нож "ABS" • Abbrechmesser ABS
• Cutter universal ABS

NUMER
KATALOGOWY

070 204



x1



18 mm



1/25/250



NÓŻ ŁAMANY KÓŁKO

Snap off cutter with wheel • Строительный нож • Abbrechmesser mit Metallführung und Drehknopf • Cutter cu protectie

NUMER
KATALOGOWY

070 205



x1



18 mm



1/25/250



NÓŻ ŁAMANY WZMOCNIONY

Snap off cutter reinforced • Строительный нож усиленный
• Abbrechmesser mit Stahlführung • Cutter cu protectie



NUMER
KATALOGOWY



070 203

x1

18 mm

1/25/250

NÓŻ DO SZKŁA OLEJOWY

Oil glass cutter • Стеклорез масляный • Öl-Glasschneider • Cutit pentru taierea sticlei cu rezervor de ulei



NUMER
KATALOGOWY



070 185

1/6/120

NÓŻ DO SZKŁA

Glass cutter • Нож для стекла • Glasschneider • Diamant sticla



NUMER
KATALOGOWY



070 209

1/12/120

NOŻYK DO FOLII

Foil & tape cutter • Нож для плёнки • Folienmesser • Cutter pentru folie



NUMER
KATALOGOWY



070 180

1/24/144

NÓŻ METALOWY TRAPEZOWY

Cutter with trapeze blades • Металлический нож (трапеция)
• Trapezmesser • Cutter cu lama trapezoidala



NUMER
KATALOGOWY



070 206

x1

1/10/100



motive
Jakość ma znaczenie



NÓŻ DO WEŁNY

Knife cutter for insulation • Нож для теплоизоляции • Dämmstoffmesser, doppelschneidig • Cutit pentru taiat vata minerala

NUMER
KATALOGOWY



070 192

280 mm

1/10/100



motive
Jakość ma znaczenie



NÓŻ DO WEŁNY Z KABURĄ

Knife cutter for insulation with sheath • Нож для теплоизоляции с кобурой • Dämmstoffmesser, doppelschneidig • Cutit pentru taiat vata minerala

NUMER
KATALOGOWY



070 193

280 mm

1/12/72



motive
Jakość ma znaczenie



NOŻY CZKI MONTERS KIE

Heavy duty scissors • Ножницы монтажные • Drahtschere • Foarfeca elctrician

NUMER
KATALOGOWY



070 198

14 cm

1/12/1200



motive
Jakość ma znaczenie



NOŻY CZKI UNI WERSALNE

Long blade scissors • Ножницы универсальные • Haushaltsschere • Foarfeca

NUMER
KATALOGOWY



070 199

28 cm

1/12/72



motive
Jakość ma znaczenie



OSTRZA ŁAMANE (10 SZT.)

Blades for cutter (10 pcs) • Лезвия отламывающиеся сменные (10 шт.) • Abbrecklingen (10 Stück im Spender) • Lame pentru cuttere (10 bucati)

NUMER
KATALOGOWY



070 215

18 mm

12/144

070 219

25 mm

12/96



OSTRZA ŁAMANE (10 SZT.)

Blades for cutter (10 pcs) • Лезвия отламывающиеся сменные (10 шт.)
• Abbrechklingen (10 Stück) • Lame pentru cuttere (10 bucati)

NUMER KATALOGOWY		
070 211	18 mm	10/400
070 216	STANLEY 18 mm	1/25



OSTRZA ŁAMANE (5 SZT.)

Blades for cutter (5 pcs) • Лезвия отламывающиеся сменные (5 шт.)
• Abbrechklingen (5 Stück) • Lame pentru cuttere (5 bucati)

NUMER KATALOGOWY		
070 214	25 mm	1/10/100



OSTRZA TRAPEZOWE (5 SZT.)

Trapeze blades (5 pcs) • Лезвия отламывающиеся сменные трапециевидные (5 шт.) • Trapezklingen (5 Stück) • Lame cutter, trapezoidale (5 bucati)

NUMER KATALOGOWY	
070 218	1/24

motive
Jakość ma znaczenie



OSTRZA TRAPEZOWE (5 SZT.)

Trapeze blades (5 pcs) • Лезвия отламывающиеся сменные трапециевидные (5 шт.) • Trapezklingen (5 Stück) • Lame cutter, trapezoidale (5 bucati)

NUMER KATALOGOWY	
070 212	1/25/600



OSTRZA HAKOWE (5 SZT.)

Hook blades (5 pcs) • Лезвия крюки (5 шт.) • Hakenklingen (5 Stück)
• Lame cutter, tip carlig

NUMER KATALOGOWY	
070 213	1/25/600





OSTRZA NOŻA DO WYKŁADZIN (5 SZT.)

Blades for carpet cutter (5 pcs) • Лезвия для ножа для ковровых покрытий (5 шт.) • Ersatzklingen für Teppichschneider (5 Stück) • Lame pentru cutter mocheta (5 buc)

NUMER
KATALOGOWY

070 217



25/200



motive
Jakość ma znaczenie



SKROBAK DO SILIKONU

Silicone sealant scraper • Нож для удаления силикона
• Silikon Fugentferner • Unealta etansare silicon

NUMER
KATALOGOWY

070 295



1/100



motive
Jakość ma znaczenie



SZPACHELKI DO SILIKONU - KOMPLET 4 SZT.

Silicone sealant spreader (4 pcs.) • Шпателя для силикона (4 шт.)
• Fugenglätter Set 4-teilig • Spatula pentru silicon (4 bucati)

NUMER
KATALOGOWY

070 299



1/100



SZPACHELKA DO SILIKONU

Sealant smoother • Шпатель для силикона • Fugenglätter
• Spatula pentru silicon

NUMER
KATALOGOWY

070 300



1/20/400



ZGARNIACZ WODY

Squeegee • Скребок для удаления воды • Fliesenwischer
• Racleta podea pentru apa

NUMER
KATALOGOWY

070 133

070 134

070 128



450 mm

600 mm

750 mm



1/10/50



1/10/30

1/10/50



ROLKA DO WYLEWEK

Spiked aeration roller • Валик для удаления воздуха в стяжках
• Entlüftungsrolle • Trafalet pentru sape



NUMER KATALOGOWY			
070 161	110 mm	230 mm	1/10
070 162	75 mm	230 mm	1/10

motive
Jakość ma znaczenie



ROLKA DO WYLEWEK

Spiked aeration roller • Валик для удаления воздуха в стяжках
• Entlüftungsrolle • Trafalet pentru sape

NUMER KATALOGOWY			
070 163	110 mm	500 mm	1/4/8

motive
Jakość ma znaczenie



SECURO

W WYGODNYM DO EKSPOZYCJI DISPLAY-U

motive
Jakość ma znaczenie

Prezentujemy Wam kolejny nóż z serii Motive. Tym razem nazwaliśmy go Securo. Dlatego **Securo**, że **oprócz tradycyjnej blokady ostrza posiada on chwilowy, bezpieczny wysuw, który automatycznie chowa ostrze, gdy nie korzystasz z noża. Sprawdź jak to działa i przekonaj się sam!**

Przeznaczony do ostrzy o szerokości 18 mm

Solidny, aluminiowy korpus

Chwilowy wysuw ostrza, bez blokady



Wysuw ostrza
ze standardową blokadą

Otwór do zawieszenia noża
(np. w warsztacie)



NOŻ SECURO

NUMER
KATALOGOWY

070 197



18 mm



1/12/24



TARCZE I WIERTŁA

ДИСКИ И СВЕРЛА • DISCS, DRILLS • TRENNSCHEIBEN UND BOHRER
• DISCURI, BURGHIE



PROFESJONALNE TARCZEDIAMENTOWE

motive
Jakość ma znaczenie



TURBO BLADE

Skuteczne cięcie betonu i kamienia. Wytrzymałe obrzeże typu turbo umożliwia również cięcie stalowych prętów zbrojeniowych. Maksymalne obroty 13 200/min (w zależności od średnicy tarczy).

MESHY BLADE

Ultracienka krawędź tnąca zapewniająca idealne cięcie glazury, terakoty, czy gresu. Grubość tarczy mniejsza niż 2 mm umożliwia również ukośne cięcia. Przeznaczona do pracy na sucho. Maksymalne obroty 13 200/min (w zależności od średnicy tarczy).



TARCZE DIAMENTOWE TURBO BLADE/MESHY BLADE

Diamond cutting disc • Диск Meshy Blade/Turbo Blade
• Diamanttrennscheibe Meshy Blade/Turbo Blade
• Disc diamantat Meshy Blade/Turbo Blade

NUMER KATALOGOWY					
080 184	MESHY BLADE	22,2 mm	1,4 mm	115 mm	1/100
080 185		22,2 mm	1,4 mm	125 mm	1/100
080 186	TURBO BLADE	22,2 mm	1,8 mm	230 mm	1/25
080 187		22,2 mm	2,2 mm	115 mm	1/100
080 188		22,2 mm	2,4 mm	125 mm	1/100
080 189		22,2 mm	2,8 mm	230 mm	1/25

ZESTAWY WIERTEŁ

motive
Jakość ma znaczenie

ZESTAW WIERTEŁ DO DREWNA



- zestaw od 4 mm do 10 mm
- stal węglowa

ZESTAW WIERTEŁ HSS DO METALU



GOLD BLACK

- zestaw od 1 mm do 10 mm
- wiertła ze stali szybko tnącej
- chwyt walcowy
- DIN 338





ZESTAW WIERTEŁ SDS DO BETONU



- zestaw od 6 mm do 10 mm
- mocowanie SDS
- widie z wolframu



ZESTAWY WIERTEŁ DO METALU • DREWNA • BETONU

NUMER KATALOGOWY			
080 210		1-10 mm	1/50
080 211		4-10 mm	1/25/100
080 212		6-10 mm	1/40



motive
Jakość ma znaczenie

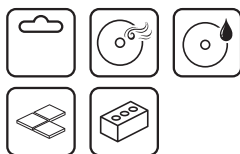

TARCA DIAMENTOWA TURBO

Diamond cutting disc • Диск алмазный TURBO • Diamanttrennscheibe Turbo
• Disc diamantat Turbo

NUMER KATALOGOWY		
080 108	115 mm	1/50
080 109	125 mm	1/50
080 110	230 mm	1/25



motive
Jakość ma znaczenie



TARCA DIAMENTOWA SUPER TURBO

Diamond cutting disc • Диск алмазный SUPER TURBO
• Diamanttrennscheibe Super Turbo • Disc diamantat Super Turbo

NUMER KATALOGOWY		
080 111	115 mm	1/50
080 112	125 mm	1/50
080 113	230 mm	1/25



motive
Jakość ma znaczenie

MESHY BLADE **TURBO BLADE**

TARCE DIAMENTOWE TURBO BLADE/BLADE

Diamond cutting disc • Диск Meshy Blade/Turbo Blade
• Diamanttrennscheibe Meshy Blade/Turbo Blade
• Disc diamantat Meshy Blade/Turbo Blade

NUMER KATALOGOWY					
080 184	MESHY BLADE	22,2 mm	1,4 mm	115 mm	1/100
080 185		22,2 mm	1,4 mm	125 mm	1/100
080 186	TURBO BLADE	22,2 mm	1,8 mm	230 mm	1/25
080 187		22,2 mm	2,2 mm	115 mm	1/100
080 188		22,2 mm	2,4 mm	125 mm	1/100
080 189		22,2 mm	2,8 mm	230 mm	1/25



TARCA DIAMENTOWA UNIWERSALNA SEGMENTOWA

Diamond cutting disc • Диск алмазный сегментный
• Diamanttrennscheibe Segment • Disc diamantat universal

NUMER KATALOGOWY		
080 101	115 mm	1/50/100
080 102	125 mm	1/50/100
080 103	180 mm	1/50
080 104	230 mm	1/25/100



TARCA DIAMENTOWA UNIWERSALNA PEŁNA

Diamond cutting disc • Диск алмазный • Diamanttrennscheibe für Fliesen
• Disc diamantat universal

NUMER KATALOGOWY		
080 105	115 mm	1/50/100
080 106	125 mm	1/50/100
080 107	230 mm	1/25



TARCA DO CIĘCIA STALI NIERDZEWNEJ

Inox cutting disc • Диск отрезной по нержавеющей стали
• INOX-Trennscheibe • Disc debitare inox

NUMER KATALOGOWY			
080 181	115 mm	1.0 mm	50/400
080 182	125 mm	1.0 mm	50/400



TARCA DO CIĘCIA METALU

Metal cutting disc • Диск отрезной по металлу • Trennscheibe für Metall
• Disc debitare metale

NUMER KATALOGOWY			
080 168	115 mm	1.0 mm	25/50/400
080 169	125 mm	1.0 mm	25/50/400
080 167	125 mm	1.5 mm	25/50/400
080 175	230 mm	1.8 mm	25/50/400



ZESTAW WIERTEŁ HSS GOLD BLACK DO METALU

Drill for metal • Сверло по металлу • Metallbohrer • Burghiu pentru metal

NUMER KATALOGOWY		
080 210	1-10 mm	1/50

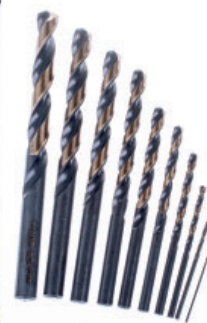

ZESTAW WIERTEŁ DO DREWNA

Drill for wood • Сверло по дереву • Holzbohrer • Burghiu pentru lemn

NUMER KATALOGOWY		
080 211	4-10 mm	1/25/100





ZESTAW WIERTEŁ SDS DO BETONU

SDS drill for concrete • Сверло по бетону SDS • SDS Bohrer • Burghiu beton SDS

NUMER
KATALOGOWY



080 212

6-10 mm

1/40



ZESTAW WIERTEŁ DO METALU

Drill for metal • Набор сверл по металлу • Metallbohrer Titanium • Burghie metal Titanium

NUMER
KATALOGOWY



080 239

1-10 mm

1/50



WIERTŁO DO METALU

Drill for metal • Сверло по металлу • Metallbohrer Titanium • Burghiu pentru metal

NUMER
KATALOGOWY



080 240

1.0 mm

10

080 241

1.5 mm

10

080 242

2.0 mm

10

080 243

2.5 mm

10

080 244

3.0 mm

10

080 245

3.2 mm

10

080 246

3.5 mm

10

080 247

4.0 mm

10

080 248

4.5 mm

10

080 249

4.8 mm

10

080 250

5.0 mm

10

080 251

5.2 mm

10

080 252

6.0 mm

10

080 253

6.4 mm

10

080 254

7.0 mm

10

080 255

8.0 mm

10

080 256

9.0 mm

5

080 257

10.0 mm

5

080 258

12.0 mm

5

080 259

14.0 mm

3





WIERTŁO SDS DO BETONU

SDS drill for concrete • Сверло по бетону SDS • SDS Bohrer • Burghiu beton SDS

NUMER KATALOGOWY			
080 300	5	110 mm	1/50
080 305	6	160 mm	1/50
080 306	6	210 mm	1/50
080 308	6	310 mm	1/25
080 312	8	160 mm	1/25
080 313	8	210 mm	1/25
080 314	8	260 mm	1/25
080 315	8	310 mm	1/25
080 319	10	160 mm	1/25
080 320	10	210 mm	1/25
080 321	10	260 mm	1/25
080 322	10	310 mm	1/25
080 323	10	350 mm	1/25
080 327	12	160 mm	1/25
080 328	12	210 mm	1/25
080 329	12	260 mm	1/25
080 330	12	310 mm	1/25
080 331	12	350 mm	1/25
080 335	14	160 mm	1/25
080 338	14	310 mm	1/25



WIERTŁO OTWORNICA

Hole saw set • Сверло корончатое • Lochsäge, 7 tlg • Fierastrau corona

NUMER KATALOGOWY		
080 200	26, 32, 38, 45, 50, 56, 63 mm	1/10/60



OTWORNICA DO BETONU Z WOLFRAMEM

Tungsten carbide grit hole saw with aluminium plate • Корончатое сверло по бетону с вольфрамом • HM-bestreute Lochsäge • Set carote cu wolfram, pentru beton

NUMER KATALOGOWY		
080 190	33, 53, 67, 73 mm	1/10/20

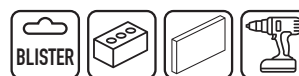

FREZ DO STYROPIANU

Cutting mill for styrofoam • Фреза для пенополистирола • Styroporfräser • Freza pentru polistiren

NUMER KATALOGOWY		
080 202	67 mm	100



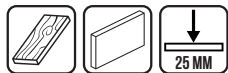

OTWORNICA DO DREWNA 8 CZĘŚCI

Hole saw set • Сверло корончатое 8 частей • Lochsäge Set 8-tlg
• Fierastrau Coroana 8 piese

NUMER
KATALOGOWY



080 201

64, 76, 89, 102, 127 mm

1/40

ARTYKUŁY RÓŻNE

PA3HOE • OTHER PRODUCTS • SONTIGES • ACCESORII





PIŁA 4-IN-1

Hand saw 4-in-1 • Ножовка 4-in-1 • Handsägebogen 4 in 1
• Fierastrau pentru taiere metale/lemn

NUMER KATALOGOWY	↔	
090 100	300 mm	1/6/24

PIŁA DO METALU

Hand saw for metal • Ножовка по металлу • Metallsäge
• Fierastrau pentru taiere metale

NUMER KATALOGOWY	↔	
090 005	300 mm	1/12/48

BRZESZCZOT BIMETAL (2 SZT.)

Bimetal hacksaw blade 2 pcs • Полотно по металлу BIMETAL (2 шт.)
• Bimetall Sägeblatt (2 Stücke) • Panza bimetala (2 bucăți)

NUMER KATALOGOWY		↔	
090 107	18/inch	300 mm	1/20

BRZESZCZOTY 2-STR.

Saw blade - metal 2 sided • Ножовочное полотно двухстороннее
• Metallsägeblatt doppelseitig • Panza (2 bucăți)

NUMER KATALOGOWY	↔		
090 109	300 mm	50 szt.	1/10

BRZESZCZOT DO METALU I DREWNA

Saw blade - wood/metal • Ножовочное полотно металл/дерево
• Metall/Holz Sägeblatt • Panza de ferastrau pentru metal si lemn

NUMER KATALOGOWY	↔		
090 108	300 mm	50 szt.	1/10

motive
Jakość ma znaczenie

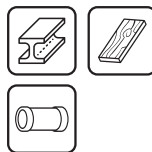

motive
Jakość ma znaczenie





motive
Jakość ma znaczenie



PIŁA DO GAZOBETONU

TCT masonry saw • Пила по газобетону • Gasbetonsäge • Fierastrau pentru BCA

NUMER
KATALOGOWY



090 009

32 zęby / 32 teeth

1/6/12



motive
Jakość ma znaczenie



PIŁA PŁATNICA

Hand saw • Пила по дереву • Handsäge • Fierastrau pentru lemn

NUMER
KATALOGOWY



090 007

450 mm

1/6/24

090 008

500 mm

1/10/120



motive
Jakość ma znaczenie



PIŁA DO PŁYT GK

Drywall saw • Пила для гипсокартона • Gipskartonsäge • Fierastrau pentru gipscarton

NUMER
KATALOGOWY



090 101

1/20/80



PIŁA DO PŁYT GK

Drywall saw • Пила для гипсокартона • Gipskartonsäge • Fierastrau pentru gipscarton

NUMER
KATALOGOWY



090 003

160 mm

1/12/72



motive
Jakość ma znaczenie



SKRZYŃKA UCIOSOWA Z PIŁĄ

Heavy duty mitre box with tenon saw • Стусло с пилой • Schneidlade mit Feinsäge • Fierastrau cu suport pentru taiere la unghi

NUMER
KATALOGOWY



090 104

45°/60°/90°

300 mm

1/20

**SKRZYŃKA UCIOSOWA Z PIŁĄ**

Mitre box with tenon saw • Стусло с пилой • Sägeset mit Feinsäge und Schneidlade • Fierastrau cu suport pentru taiere la unghi

NUMER
KATALOGOWY

090 105

45°/90°

300 mm

1/24

**SKRZYŃKA UCIOSOWA DREWNIANA**

Wooden mitre box • Стусло деревянное • Schneidlade • Suport fierastrau pentru taiere la unghi

NUMER
KATALOGOWY

090 106

45°/90°

300 mm

1/10

**SKRZYŃKA NARZĘDZIOWA 12"**

Tool box • Ящик для инструмента • Kunststoff - Werkzeugkoffer • Cutie pentru scule

NUMER
KATALOGOWY

100 359

312 x 167 x 130 mm

1

**SKRZYŃKA NARZĘDZIOWA 16"**

Tool box • Ящик для инструмента • Kunststoff - Werkzeugkoffer • Cutie pentru scule

NUMER
KATALOGOWY

100 360

415 x 226 x 200 mm

1

**SKRZYŃKA NARZĘDZIOWA 20"**

Tool box • Ящик для инструмента • Kunststoff - Werkzeugkoffer • Cutie pentru scule

NUMER
KATALOGOWY

100 361

525 x 256 x 246 mm

1



**SKRZYŃKA NARZĘDZIOWA 500 PROFi**

Tool box PROFi • Ящик для инструмента "PROFi" • Kunststoff - Werkzeugkoffer Profi • Cutie pentru scule Profi

NUMER
KATALOGOWY

100 370



462 x 256 x 242 mm



1

**SKRZYŃKA NARZĘDZIOWA 600 PROFi**

Tool box PROFi • Ящик для инструмента "PROFi" • Kunststoff - Werkzeugkoffer Profi • Cutie pentru scule Profi

NUMER
KATALOGOWY

100 371



547 x 271 x 278 mm



1

**SKRZYŃKA NARZĘDZIOWA 700 PROFi**

Tool box PROFi • Ящик для инструмента "PROFi" • Kunststoff - Werkzeugkoffer Profi • Cutie pentru scule Profi

NUMER
KATALOGOWY

100 372



595 x 289 x 328 mm

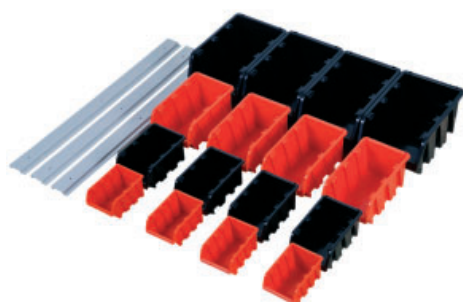

1

**KUWETA NARZĘDZIOWA 16 SZT + 3 LISTWY**

Plastic storage bins with wall mounting rails • Кювета для инструмента 16 шт + 3 планки • Sichtlagerkästen 16 tlg • Set 16 cutii pentru depozitare

NUMER
KATALOGOWY

100 375



60 x 80 x 115 mm

70 x 100 x 155 mm

90 x 120 x 195 mm

120 x 160 x 230 mm



1

**SKRZYŃKA NA DROBNICĘ**

Plastic container • Ящик для мелочи • Sortierbox • Organizer

NUMER
KATALOGOWY

100 380



90 x 180 x 35 mm

100 381

200 x 160 x 35 mm



1

1



SKRZYŃKA NA DROBNICĘ Z UCHWYTEM

Plastic container with handle • Ящик для мелочи с ручкой • Sortierbox mit Griff • Organizer

NUMER KATALOGOWY		
100 385	85 x 245 x 135 mm	1
100 386	85 x 295 x 180 mm	1
100 387	85 x 238 x 359 mm	1
100 388	85 x 298 x 400 mm	1



ZESTAW BITÓW DO WKREŹTARKI 10 SZT.

Screwdriver bits (10 pcs) • Биты с магнитом (10 шт.) • Schrauberbit Set 10-teilig • Biti pentru insurubare (10 bucati)

NUMER KATALOGOWY			
100 321	PH1 x 2, PH2 x 2, PZ1 x 2, PZ2 x 2, SL5 x 1, SL6 x 1	25 mm	1/100/200



BITY DO WKREŹTARKI 5 SZT.

Screwdriver bits (5 pcs) • Биты с магнитом (5 шт.) • Schrauberbit Set (5-teilig) • Biti pentru insurubare (5 bucati)

NUMER KATALOGOWY			
100 322	PH1	25 mm	1/100/200
100 323	PH1	50 mm	1/100/200
100 324	PH2	25 mm	1/100/200
100 325	PH2	50 mm	1/100/200
100 326	PH3	25 mm	1/100/200
100 327	PH3	50 mm	1/100/200
100 328	PZ1	25 mm	1/100/200
100 329	PZ1	50 mm	1/100/200
100 330	PZ2	25 mm	1/100/200
100 331	PZ2	50 mm	1/100/200
100 332	PZ3	25 mm	1/100/200
100 333	PZ3	50 mm	1/100/200



BITY PH2 Z OGRANICZNIKIEM

Plasterboard bits • Биты с ограничителем • Bits für Gipskarton mit Tiefenstopp • Biti pentru gips carton

NUMER KATALOGOWY		
100 334	25 mm	1/100/200



**motive**
Jakość ma znaczenie**UCHWYT MAGNETYCZNY DO BITÓW**Bit holder with magnet • Магнитный держатель для бит • Magnet Bithalter
• Prelungitor magnetic pentru biti de insurubareNUMER
KATALOGOWY

100 335

60 mm

1/100/200

**motive**
Jakość ma znaczenie**PODPORA TELESKOPOWA**Extension support • Телескопическая опора • Teleskopstütze
• Suport telescopicNUMER
KATALOGOWY

MAX:



090 830

60 kg

0,7 m - 1,15 m

1/6

090 831

60 kg

1,6 m - 2,9 m

1/6

**motive**
Jakość ma znaczenie**OŁÓWEK STOLARSKI**Carpenter pencil blue • Столярный карандаш • Zimmermannsbleistift
• Creion tamplarieNUMER
KATALOGOWY

090 041

1/50

**motive**
Jakość ma znaczenie**OŁÓWEK MURARSKI**

Bricklayer pencil green • Карандаш каменщика • Maurerbleistift • Creion zidar

NUMER
KATALOGOWY

090 042

1/50

**motive**
Jakość ma znaczenie**OŁÓWEK DO SZKŁA I GLAZURY**Pencil for glass and glaze • Карандаш для стекла и плитки • Fliesenbleistift "T"
• Creion sticla si ceramicaNUMER
KATALOGOWY

090 043

1/50



OŁÓWEK DO MOKRYCH POWIERZCHNI KB MOTIVE

Pencil for wet surfaces • Карандаш для мокрых поверхностей
• Bleistift für nasse Oberflächen • Creion trasare suprafete umede si lucioase

NUMER
KATALOGOWY



090 068

1/50

OŁÓWEK STOLARSKI DWUPAK

Carpenter pencil x2 • Столярный карандаш x2 • Zimmermannsbleistift x2
• Creion tamplarie

NUMER
KATALOGOWY



090 067

1/36

OŁÓWEK STOLARSKI

Carpenter pencil • Столярный карандаш • Zimmermannsbleistift
• Creion tamplarie

NUMER
KATALOGOWY



090 040

50/600/1200

TEMPERÓWKA DO OŁÓWKÓW STOLARSKICH

Pencil sharpener • Точилка для карандашей • Anspitzer für
Zimmermannsbleistifte • Ascuzitoare creioane tamplarie

NUMER
KATALOGOWY



090 039

1/100/800

MARKER PERMANENTNY

Marker • Перманентный маркер • Permanentmarker schwarz
• Marker permanent

NUMER
KATALOGOWY



100 110

□

1/10

100 111

■

1/10

100 112

■

1/10

100 113

■

1/10

100 114

■

1/10

motive
Jakość ma znaczenie



motive
Jakość ma znaczenie



motive
Jakość ma znaczenie



**MARKER PERMANENTNY DWUSTRONNY**

Twin tip permanent marker • Перманентный маркер • Marker mit zwei Spitzen
• Marker permanent cu 2 capete

NUMER
KATALOGOWY



100 119

1/10/1000

**MARKER OLEJOWY BIAŁY**

Oil-based paint marker • Маркер масляный белый • Öl basierte Paint Marker
• Marker alb pe baza de ulei

NUMER
KATALOGOWY



100 117

1/10/1000

**MARKER OLEJOWY BIAŁY**

Oil-based paint marker • Маркер масляный белый • Öl basierte Paint Marker
• Marker alb pe baza de ulei

NUMER
KATALOGOWY



000216

1/12/144

**KREDA BUDOWLANA**

Marking crayon • Мелок строительный • Krits vaska • Signierkreide • Cretă
forestieră și pentru semnat

NUMER
KATALOGOWY



090 062



10

090 063



10

090 064



10

**KREDA TRASERSKA 115 G**

Chalk line powder 115 g • Трассировочный мел 115 гр
• Schlagschnurpulver 115 g • Praf creta 115 g

NUMER
KATALOGOWY



090 065



1/10/100

090 066



1/10/100



SZNUR TRASERSKI FAST

Chalk line FAST • Трассировочный шнур FAST • Schlagschnur
• Dispozitiv de trasat ata cu creta

NUMER
KATALOGOWY



090 057

30 m

1/10



SZNUR TRASERSKI

Chalk line • Трассировочный шнур • Schlagschnur • Dispozitiv de trasat cu fir

NUMER
KATALOGOWY



090 054

30 m

1/10/100



SZNUR TRASERSKI ABS

Chalk line ABS • Трассировочный шнур ABS • Schlagschnur ABS
• Dispozitiv de trasat cu fir ABS

NUMER
KATALOGOWY



090 056

30 m

1/10/100



MIARA ABS

Measuring tape ABS • Рулетка • Bandmaß ABS • Ruleta ABS

NUMER
KATALOGOWY



090 076

25 mm

5 m

1/6/72



MIARA STALOWA

Measuring tape • Рулетка • Bandmaß • Ruleta metalica

NUMER
KATALOGOWY



090 074

25 mm

5 m

1/6/72





motive
Jakość ma znaczenie



MIARA STALOWA AUTO-LOCK

Measuring tape AUTO-LOCK • Рулетка AUTO-LOCK • Bandmaß AUTO-LOCK
• Ruleta Auto-Lock

NUMER KATALOGOWY			
090 075	25 mm	5 m	1/6/72



motive
Jakość ma znaczenie

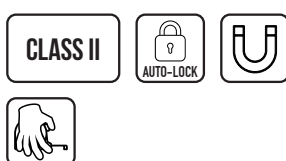

MIARA STALOWA

Steel measuring tape • Рулетка металлическая • Bandmaß Edelstahlgehäuse
• Ruleta metalica

NUMER KATALOGOWY			
090 071	15 mm	3 m	1/12
090 072	20 mm	5 m	1/12
090 073	25 mm	8 m	1/6



motive
Jakość ma znaczenie



MIARA ZWIJANA PROFI

Measuring tape PROFI • Рулетка PROFI • Bandmaß PROFI • Ruleta Profi

NUMER KATALOGOWY			
090 046	15 mm	3 m	1/12
090 047	20 mm	5 m	1/12
090 048	25 mm	8 m	1/6



motive
Jakość ma znaczenie



MIARA AUTO-LOCK

Auto-lock measuring tape • Рулетка AUTO-LOCK • Bandmaß Auto-Lock
• Ruleta Auto-Lock

NUMER KATALOGOWY			
090 025	15 mm	3 m	1/12/120
090 026	20 mm	5 m	1/12/96
090 027	25 mm	8 m	1/6/48



motive
Jakość ma znaczenie



MIARA ZWIJANA SOFT

Measuring tape soft grip case • Рулетка SOFT • Bandmaß SOFT • Ruleta Soft

NUMER KATALOGOWY			
090 033	15 mm	2 m	1/12/120
090 034	15 mm	3 m	1/12/120
090 035	20 mm	5 m	1/12/120
090 036	25 mm	8 m	1/6/60
090 037	25 mm	10 m	1/6/60



MIARA DREWNIANA

Wooden folding ruler • Метр деревянный • Gliedermaßstab • Metru lemn

NUMER KATALOGOWY		
090 013	2 m	1/10/200



TAŚMA MIERNICZA WBIJANA

Open reel fibreglass tape • Рулетка геодезическая • Fibreglas Bandmaß • Ruleta

NUMER KATALOGOWY		
090 017	30 m	1/24
090 018	50 m	1/16



TAŚMA MIERNICZA

Fiberglass measure tape • Рулетка геодезическая • Fibreglas Bandmaß • Ruleta

NUMER KATALOGOWY		
090 019	30 m	1/60



SZNUR MURARSKI

Mason's line • Шнур каменщика • Maurerschnur • Sfoară zidărie

NUMER KATALOGOWY				
090 050		50 m	1,2 mm	1/12/144
090 051		50 m	1,7 mm	1/12/144
090 052		100 m	1,2 mm	1/6/144
090 053		100 m	2 mm	1/6/144



SZNUREK POLIPROPYLENOWY

Polypropylene twine • Шнур полипропиленовый • PP-Kordel • Sfoara polipropilena

NUMER KATALOGOWY			
090 055	0,5 kg	(500 m +/- 8%)	1/10



**SZNUREK POLIPROPYLENOWY UV**Polypropylene twine • Шнур полипропиленовый • PP-Kordel
• Sfoara polipropilenaNUMER
KATALOGOWY

090 049

1200 m

1/10

**motive**
Jakość ma znaczenie**ŻYŁKA GOSPODARCZA**General purpose nylon line • Хозяйственная леска
• Synthetischer Maurerschnur • Sfoară zidărie gutăNUMER
KATALOGOWY

090 059

1,3 mm

100 m

1/50

**ŻYŁKA GOSPODARCZA**General purpose nylon line • Хозяйственная леска
• Synthetischer Maurerschnur • Sfoară zidărie gutăNUMER
KATALOGOWY

090 060

0,8 mm

100 m

1/100

**motive**
Jakość ma znaczenie**HEAVY
DUTY****WYCISKACZ HD**Caulking gun HD • Пистолет для герметиков HD • Kartuschenpistole HD
• Pistol silicon HDNUMER
KATALOGOWY

090 165

300 ml

1/12

**motive**
Jakość ma znaczenie**HEAVY
DUTY****WYCISKACZ STRONG**Caulking gun STRONG • Пистолет для герметиков STRONG
• Kartuschenpistole "Strong" • Pistol silicon StrongNUMER
KATALOGOWY

090 160

300 ml

1/12



WYCISKACZ PROFI

PROFI caulking gun • Пистолет для герметиков PROFI
• Kartuschenpistole Profi • Pistol silicon Profi

NUMER KATALOGOWY		
090 125	300 ml	1/12

motive
Jakość ma znaczenie



WYCISKACZ DO SILIKONU

Caulking gun • Пистолет для герметиков • Kartuschenpistole • Pistol silicon

NUMER KATALOGOWY		
090 127	300 ml	1/12

motive
Jakość ma znaczenie



WYCISKACZ DO MAS USZCZELNIAJĄCYCH

Tube caulking gun • Пистолет для герметиков • Auspresspistole Alu
• Presa silicon tip salam

NUMER KATALOGOWY		
090 119	300 ml	1/12
090 118	600 ml	1/12

motive
Jakość ma znaczenie



WYCISKACZ DO SILIKONU SZKIELETOWY

Skeleton caulking gun • Скелетный пистолет для герметиков
• Kartuschenpistole • Pistol silicon

NUMER KATALOGOWY		
090 121	300 ml	1/12



WYCISKACZ DO SILIKONU

Caulking gun • Полукопусный пистолет для герметиков
• Kartuschenpistole • Pistol silicon

NUMER KATALOGOWY		
090 120	300 ml	1/12



**WYCISKACZ PLASTIKOWY**Plastic caulking gun • Пистолет для герметиков пластмассовый
• Kartuschenpistole Plastik • Pistol silicon plasticNUMER
KATALOGOWY

090 124

300 ml

1/12

**KOŃCÓWKI WYCISKACZA DO MAS**Tube caulking gun spare nozzles • Наконечники к пистолету для герметиков
• Ersatzspitzen für Auspresspistole • Duze pistol siliconNUMER
KATALOGOWY

090 117

10/500

 **motive**
Jakość ma znaczenie

PTFE

**PISTOLET DO PIANKI MONTAŻOWEJ**PTFE coated pu foam gun • Пистолет для монтажной пены с тефлоновым
покрытием • PU Schaumpistole • Pistol pentru spuma poliuretanică PTFENUMER
KATALOGOWY

090 128

1/20

**PISTOLET DO PIANKI MONTAŻOWEJ**PU foam gun • Пистолет для монтажной пены • PU Schaumpistole
• Pistol pentru spuma poliuretanicăNUMER
KATALOGOWY

090 126

1/20

**PISTOLET DO PIANKI MONTAŻOWEJ MINI**Mini PU foam gun • Пистолет для монтажной пены MINI
• PU Schaumpistole Mini • Pistol pentru spuma poliuretanicăNUMER
KATALOGOWY

090 129

1/100



ZSZYWACZ TAPICERSKI PROFI

Staple gun PROFI • Стенлеп PROFI • Handtacker Profi • Capsator tapiterie Profi

NUMER KATALOGOWY		
090 131	4-14 mm	1/10/40

ZSZYWACZ TAPICERSKI

Staple gun • Стенлеп • Handtacker • Capsator tapiterie

NUMER KATALOGOWY		
090 130	4-14 mm	1/10/40

ZSZYWKA (1000 SZT.)

Staples (1000 pcs) • Скобы для степлера (1000 шт.)
• Tackerklammern (1000 Stück) • Capse tapiterie (1000 bucati)

NUMER KATALOGOWY		
090 141	6 mm	1/50/200
090 142	8 mm	1/50/200
090 143	10 mm	1/50/200
090 144	12 mm	1/50/200
090 145	14 mm	1/50/200

ZSZYWKA STANLEY (1000 SZT.)

STANLEY staples (1000 pcs) • Скобы для степлера "STANLEY" (1000 шт.)
• Stanley Tackerklammern (1000 St.) • Capse tapiterie Stanley (1000 bucati)

NUMER KATALOGOWY		
090 151	6 mm	1/6
090 152	8 mm	1/6
090 153	10 mm	1/5
090 154	12 mm	1/5
090 155	14 mm	1/5

USZCZELKA

EPDM Rubber weatherstrip seal • Уплотнитель для окон
• Selbstklebende Dichtung • Banda de etansare ferestre

NUMER KATALOGOWY		
090 200		100 m 1/6
090 201		100 m 1/6
090 202		100 m 1/6
090 203		100 m 1/6
090 204		150 m 1/6
090 205		150 m 1/6
090 211		6 m 1/36
090 212		6 m 1/36
090 209		6 m 1/36
090 210		6 m 1/36
090 213		6 m 1/36
090 214		6 m 1/36



STANLEY

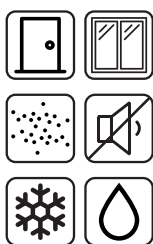

**USZCZELKA PU**Foam seal • Паролон для утепления окон тип "PU" • Schaumstoffdichtung PU
• Banda autoadeziva pentru etansare din burete

NUMER KATALOGOWY					
090 206	PU 1	6 m	5 mm	9 mm	1/100
090 207	PU 2	6 m	8 mm	10 mm	1/200
090 208	PU 3	5 m	10 mm	12 mm	1/100

**PASY TRANSPORTOWE**Ratchet tie down • Ленты для крепления груза • Spanngurt
• Chinga de ancoraj cu clichet si carlig

NUMER KATALOGOWY					
090 300	3.8 m	25 mm	270 kg	540 kg	1/30
090 301	3.8 m	27 mm	500 kg	1000 kg	1/20
090 302	3 m	27 mm	600 kg	1200 kg	1/20
090 303	3.8 m	38 mm	1000 kg	2000 kg	1/20
090 304	6 m	50 mm	2500 kg	5000 kg	1/10
090 305	6.8 m	50 mm	2500 kg	5000 kg	1/10
090 306	8 m	50 mm	2500 kg	5000 kg	1/10
090 307	10 m	50 mm	2500 kg	5000 kg	1/10
090 308	12 m	50 mm	2500 kg	5000 kg	1/10

**motive**
Jakość ma znaczenie**KŁÓDKA MOSIĘŻNA**

Brass padlock • Замок латунный • Pakabinama spyna, žalvarinē • Messing-Vorhängschloss

NUMER KATALOGOWY		
090 601	40 mm	1/12/300
090 602	50 mm	1/12/120
090 603	60 mm	1/12/120

**KŁÓDKA ŻELIWNA**Iron padlock • Чугунный висячий замок • Vorhängeschloss aus Gusseisen
• Lacat din fier

NUMER KATALOGOWY		
090 620	30 mm	1/12/120
090 621	40 mm	1/12/96
090 622	50 mm	1/12/72
090 623	60 mm	1/12/48
090 624	75 mm	1/12/24

**KŁÓDKA TRZPIENIOWA WZMOCNIONA**Brass rectangular padlock • Стержневой латунный висячий замок
• Monoblock-Vorhängeschloss • Lacat dreptunghiular

NUMER KATALOGOWY	↔	
090 610	70 mm	1/6/48
090 611	80 mm	1/6/48
090 612	90 mm	1/6/36

**ŁOPATA DO ŚNIEGU WZMACNIANA**Shovel for snow strengthened • Лопата для снега усиленная
• Schneeschaukel- verstärkt • Lopata pentru zapada

NUMER KATALOGOWY		
040 525	460 x 420 x 1350 mm	1/10/120

**ŁOPATA DO ŚNIEGU**

Shovel for snow • Лопата для снега • Schneeschaukel • Lopata pentru zapada

NUMER KATALOGOWY		
040 520	360 x 460 x 1300 mm	1/120

**SKUWACZ DO LODU**

Ice chopper • Ледоруб • Eisstösser • Spargator pentru gheata

NUMER KATALOGOWY		
040 530	200 x 90 x 1050 mm	1/10



**SPYCHACZ RĘCZNY DO ŚNIEGU**Snow pusher • Лопата „Бульдозер” для снега • Schneewanne mit Rollen
• Lopata impingator cu rotiNUMER
KATALOGOWY

040 521

790 x 430 x 1400 mm

1/10

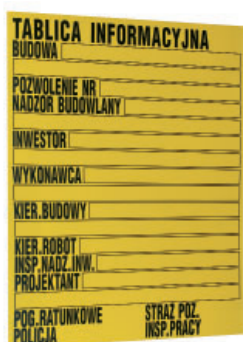

PVC

TABLICA INFORMACYJNA

Information signboard • Доска строительная • Bautafel • Panou santier

NUMER
KATALOGOWY

090 630

700 x 900 mm

1/50

090 629

500 x 700 mm

1/50

**PRÓBNIK ELEKTRYCZNY**Voltage tester screwdriver • Индикатор напряжения-отвертка
• Spannungsprüfer • Surubelnita dreapta creion de tensiuneNUMER
KATALOGOWY

V



100 320

110 - 250

1/24

**motive**
Jakość ma znaczenie**NAŚWIETLACZ LED**

Led fixture • Светодиодный прожектор • LED Strahler • Projector LED

NUMER
KATALOGOWY

W

V/Hz



090 730

10 W

230 / 50

4000 K

1/24

090 731

20 W

230 / 50

4000 K

1/16

090 732

30 W

230 / 50

4000 K

1/12

090 737

50 W

230 / 50

6500 K

1/8

090 745 uchwyt/handle

30 W

230 / 50

4000 K

1/4



NAŚWIETLACZ LED

Led fixture • Светодиодный прожектор • LED Strahler • Projector LED

NUMER KATALOGOWY		W	V/Hz		
090 740	STATYW	30 W	230 / 50	4000 K	1/4
090 743	STATYW	2 x 50 W	230 / 50	6500 K	1

motive
Jakość ma znaczenie



PRZEDŁUŻACZ BĘBNOWY

Extension reel, 4 sockets • Удлинитель катушечный • Kabeltrommel • Derulator cablu electric

NUMER KATALOGOWY			V/Hz	V/A MAX	
090 690	4	1.5 mm	230 / 50	250 / 16	1/2
090 691	4	1.5 mm	230 / 50	250 / 16	1/4
090 692	4	2.5 mm	230 / 50	250 / 16	1/4



PRZEDŁUŻACZ JEDNOGNIAZDOWY

Extension lead • Удлинитель оголодный • Verlängerungskabel • Prelungitor cu fisa si cupla, contact de protectie

NUMER KATALOGOWY			V/Hz	V/A MAX	
090 696	1.5 mm	25 m	230 / 50	250 / 16	1/6
090 697	1.5 mm	40 m	230 / 50	250 / 16	1/4



PISTOLET KLEJOWY

Glue gun • Пистолет для клея • Heißklebepistole • Pistol de lipit

NUMER KATALOGOWY	V/Hz	W	
090 223	230 / 50	120	1/10

motive
Jakość ma znaczenie





motive
Jakość ma znaczenie



WKŁADY KLEJOWE (10 SZT.)

Glue sticks (10 pcs) • Клеевые вкладыши (10 шт.) • Klebestangen für Klebepistole (10 Stück) • Baghete silicon pentru pistolul de lipit (10 buc)

NUMER KATALOGOWY			
090 224	11,2 mm	200 mm	10/60



PISTOLET KLEJOWY

Glue gun • Пистолет для клея • Heißklebepistole • Pistol de lipit

NUMER KATALOGOWY	V/Hz	W	
090 221	230 / 50	20 W	1/24



WKŁADY KLEJOWE (50 SZT.)

Glue sticks (50 pcs) • Клеевые вкладыши (50шт.) • Klebestangen für Klebepistole (50 Stück) • Baghete silicon pentru pistolul de lipit (50 buc)

NUMER KATALOGOWY			
090 222	11,2 mm	200 mm	1/10/50



OPASKI ZACISKOWE CZARNE

Fixing ties, black • Хомуты пластиковые черные • Kabelbinder schwarz • Colier cablu negru

NUMER KATALOGOWY		
090 661	2,5 x 150 mm (100 szt.)	1/125/250
090 663	3,6 x 150 mm (100 szt.)	1/125/250
090 665	3,6 x 200 mm (100 szt.)	1/125/200
090 667	3,6 x 250 mm (100 szt.)	1/125/200
090 669	4,8 x 200 mm (100 szt.)	1/50/100
090 671	4,8 x 300 mm (100 szt.)	1/50/100
090 673	4,8 x 350 mm (100 szt.)	1/90
090 675	4,8 x 450 mm (100 szt.)	1/70
090 677	9,0 x 550 mm (50 szt.)	1/40
090 679	9,0 x 760 mm (50 szt.)	1/20

OPASKI ZACISKOWE BIAŁE

Fixing ties, white • Хомуты пластиковые белые • Kabelbinder weiß • Colier cablu alb

NUMER KATALOGOWY		
090 660	2,5 x 150 mm (100 szt.)	1/125/250
090 662	3,6 x 150 mm (100 szt.)	1/125/250
090 664	3,6 x 200 mm (100 szt.)	1/125/200
090 666	3,6 x 250 mm (100 szt.)	1/125/250
090 668	4,8 x 200 mm (100 szt.)	1/50/100
090 670	4,8 x 300 mm (100 szt.)	1/50/100
090 672	4,8 x 350 mm (100 szt.)	1/90
090 674	4,8 x 450 mm (100 szt.)	1/70
090 676	9,0 x 550 mm (50 szt.)	1/40
090 678	9,0 x 760 mm (50 szt.)	1/20



NARZĘDZIA I AKCESORIA STOLARSKIE

СТОЛЯРНЫЙ ИНСТРУМЕНТ И АКЦЕССУАРЫ • WOODWORKING TOOLS

• TISCHLERWERKZEUG • UNELTE PENTRU PRELUCRAT LEMN





KĄTOWNIK STOLARSKI DO ZACISKANIA



KĄTOWNIK STOLARSKI DO ZACISKANIA

to kolejne niezbędne akcesorium na wyposażeniu warsztatu domowego lub stolarskiego. Służy do stabilizacji kąta prostego podczas klejenia i montażu m.in. szafek, szuflad, czy ramek. Jest bardzo wygodny w użytkowaniu. Dotyczy to zarówno przymiaru kątownika do zewnętrznych, jak i wewnętrznych narożników. Kątownik jest odporny na mechaniczne uszkodzenia i pęknięcia, co świadczy o jego solidnym wykonaniu. Nie podlega praktycznie żadnej deformacji.

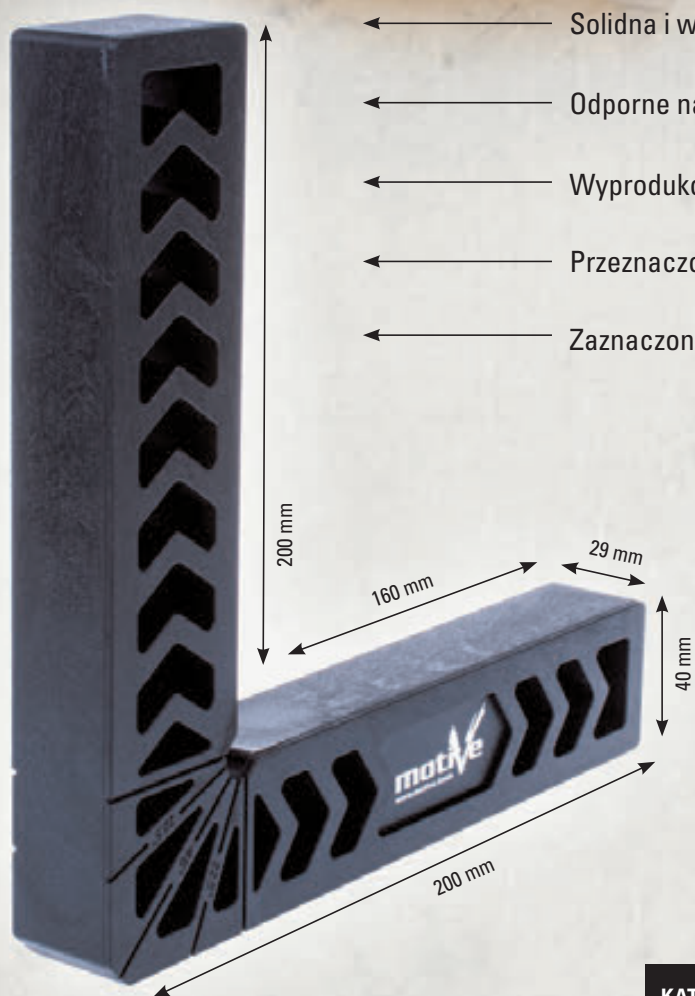

- ← Solidna i wytrzymała konstrukcja z poliwęglanu
- ← Odporne na mechaniczne uszkodzenia tworzywo
- ← Wyprodukowany z dużą dokładnością i starannością
- ← Przeznaczony do pracy również z silnymi ściskami stolarskimi
- ← Zaznaczone po obu stronach kątownika kąty: 22,5° i 45°

**HEAVY
DUTY**



Zaokrąglone zagłębienie wewnątrz ułatwiające dokładniejsze spasowanie łączonych elementów

nr kat. 110 105

KĄTOWNIK STOLARSKI DO ZACISKANIA

90 degree clamping square • Угольник столярный монтажный
• Spannwinkel • Echer tamplarie



NUMER
KATALOGOWY

110 105



200 x 200 mm



1/40

ŚCISK PEŁNOPOWIERZCHNIOWY

AKCESORIA
I NARZĘDZIA
STOLARSKIE



HEAVY
DUTY

ŚCISKI PEŁNOPOWIERZCHNIOWE

to fachowe i niezawodne przyrządy niezbędne w każdym warsztacie. Dedykowane są zarówno profesjonalistom, jak i majsterkowiczom. Dzięki nim możesz ścisnąć i unieruchomić sklejane ze sobą elementy. Z powodzeniem również stabilnie zamocujesz do blatu lub stołu praktycznie każdy materiał podczas jego obróbki. Korzystając z kolei z opcji rozpierającej możesz np. właściwie ustawić i unieruchomić ościeżnicę, podczas jej piankowania. Nasze ściski przydatne są do wszelkich prac wymagających użycia znacznych sił statycznych. Polecamy!



90 mm

Bardzo głęboki chwyt

nr kat. 110 102



MODEL
900

Zakres pracy ścisku: max. 900 mm

nr kat. 110 101



MODEL
600

max. 600 mm

nr kat. 110 100



MODEL
450

max. 450 mm

Duża siła ścisku

Łatwo dostępny cyngiel zwalniający

Blokada do zmiany ustawień

Solidny, dwukompozytowy korpus

Szybka i łatwa zmiana ścisku w rozpierek
(rozpiera od 710 do 1170 mm, zależnie od wybranego modelu)

Mocna i wytrzymała na przeciążenia stalowa prowadnica

ŚCISK PEŁNOPOWIERZCHNIOWY

Bar clamp gun • Зажим плотника пистолетного типа
• Einhandzwinde • Menghina de man



NUMER
KATALOGOWY



110 100

450 mm

1/6

110 101

600 mm

1/6

110 102

900 mm

1/6

ZACISKOWE LISTWY PROWADZĄCE

motive



**Chcesz przyciąć płytę dożądanego wymiaru?
Nie masz odpowiedniej listwy?**

**Skorzystaj z naszych listew prowadzących.
Do wyboru masz dwie serie listew o różnych długościach.**

Te uniwersalne listwy, dostępne w trzech długościach mogą być użyte z każdą piłą tarczową, zagłębiarką, wyrzynarką, czy też frezarką. Przy ich pomocy z łatwością przytniesz płytę meblową, OSB, sklejkę albo drewniany blat. Używając natomiast nożyka lub piły ręcznej dotniesz również arkusz PCV, czy płytę karton-gips. Listwy posłużyć mogą do wyznaczania linii, a zaciśnięte na blacie spełnią funkcję przymiaru lub zderzaka.

SERIA LISTEW Z DOSTĘPNYMI PRZEDŁUŻKAMI



LISTWY PODSTAWOWE

Clamp cutting guide • Планка-направляющая
• Führungsschiene • Riglă de ghidare

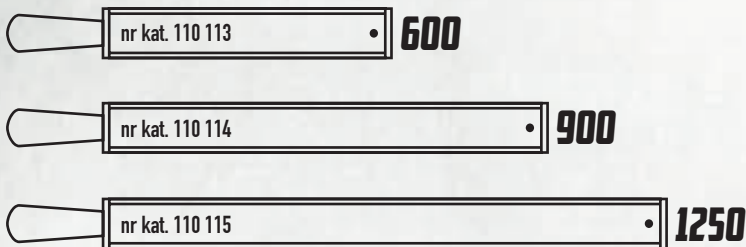

LISTWY PRZEDŁUŻAJĄCE

Cutting guide extension • Удлинитель стальной направляющей с зажимом • Verlängerung für Führungsschiene • Riglă de ghidare

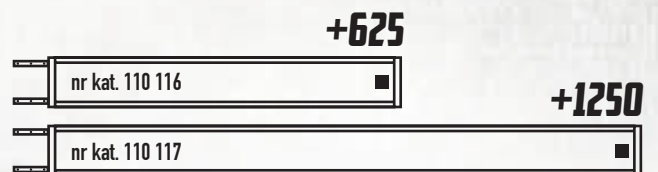

SERIA WĘŻSZYCH LISTEW Z WYCHYLNymi ZACISKAMI, BEZ MOŻLIWOŚCI PRZEDŁUŻANIA

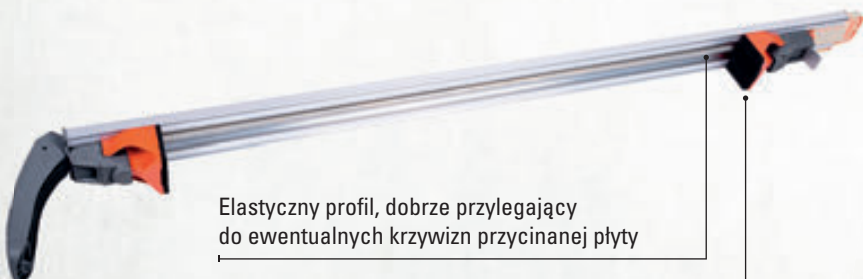

LISTWY PODSTAWOWE

Clamp cutting guide • Планка-направляющая
• Führungsschiene • Riglă de ghidare

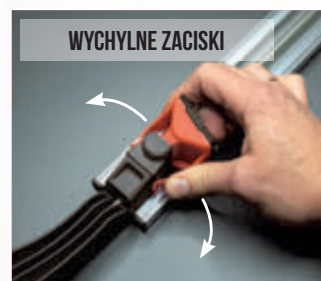
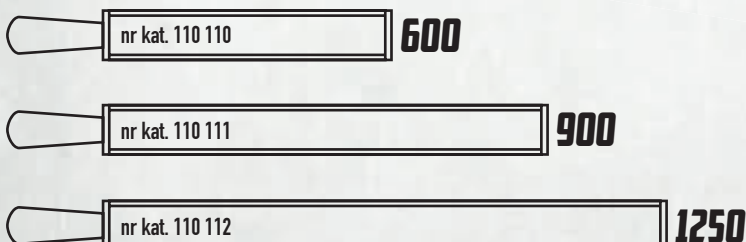

Stalowy pręt wzmacniający

Wychylne na boki zaciski ułatwiający cięcie nieforemnych płyt

Kilkustopniowa siła zacisku





motive
Jakość ma znaczenie



ŚCISK STOLARSKI SPRĘŻYNOWY

Spring clamp • Зажим плотника пружинный • Leimklemme
• Menghina de mana

NUMER KATALOGOWY			
090 801	12 kg	max 50 mm	1/240
090 802	15 kg	max 63 mm	1/120
090 803	17 kg	max 75 mm	1



motive
Jakość ma znaczenie



ŚCISK STOLARSKI ŚRUBOWY

F Type clamp • Зажим плотника винтовой • Schraubzwinge
• Menghina cu surub, din fonta

NUMER KATALOGOWY			
090 810	50 mm	100 mm	1/50
090 811	50 mm	200 mm	1/50
090 812	80 mm	200 mm	1/30
090 813	80 mm	300 mm	1/30
090 814	120 mm	300 mm	1/20
090 815	120 mm	500 mm	1/12



motive
Jakość ma znaczenie



ŚCISK STOLARSKI PISTOLETOWY

Bar clamp • Зажим плотника пистолетного типа • Einhandzwinge
• Menghina de mana

NUMER KATALOGOWY		
090 820	max 100 mm	1/100
090 821	max 150 mm	1/12
090 822	max 300 mm	1/12



motive
Jakość ma znaczenie



KĄTOWNIK STOLARSKI ALUMINIOWY

Metal angle ruler • Угломер металлический • Bauwinkel • Echer tamplarie

NUMER KATALOGOWY		
110 120	300 mm x 300 mm	1



KĄTOWNIK STOLARSKI

Carpenter angle ruler • Угломер столярный • Schreinerwinkel • Echer tamplarie

NUMER KATALOGOWY		
040 814	350 mm	1/12/60

DRABINY

ЛЕСТНИЦЫ • LADDERS

• LEITERN • SCĂRI



DRABINA WOLNOSTOJĄCA

FARAONE

to drabina przeznaczona do intensywnych i profesjonalnych prac montażowych czy magazynowych. Dzięki szerokim na 8 cm, ryflowanym stopniom drabina jest bezpieczna i ergonomiczna. Mocna i trwała konstrukcja, specjalny lotniczy system montażu stopni zapewnia 100% bezpieczeństwo podczas użytkowania drabiny. Dla zwiększenia wygody i ergonomii użytkowania drabina została wyposażona w praktyczną torbę na narzędzia. Stabilność drabiny została zwiększona dzięki zastosowaniu wzmocnienia w postaci zamontowanego krzyża stabilizującego w tylnej części drabiny oraz wzmocnień w narożnikach pomiędzy pierwszym stopniem, a podłużnicą.



praktyczna kieszeń na narzędzia

antypoślizgowy podest

krzyżowy system stabilizacji

nitowane, ryflowane stopnie

poprzeczki wzmocniające w narożnikach

antypoślizgowe stopki



O SZCZEGÓŁY I DOSTĘPNOŚĆ
ZAPYTAJ HANDLOWCĘ W TWOIM REGIONIE

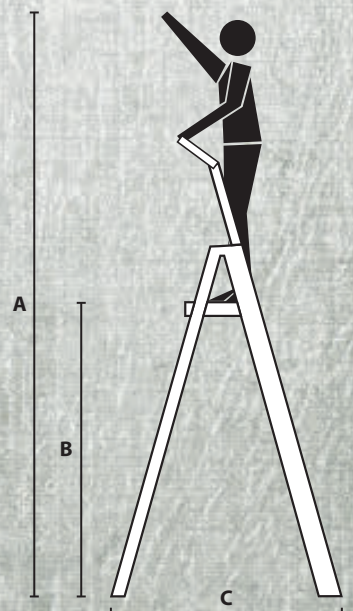
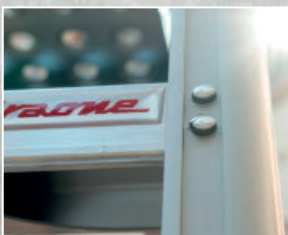

DRABINA WOLNOSTOJĄCA

NUMER KATALOGOWY				A	B	C	
LADY4	7,3 kg	150 kg	4	267 cm	87 cm	86 cm	1
LADY5	8,5 kg	150 kg	5	290 cm	110 cm	102 cm	1
LADY6	9,3 kg	150 kg	6	313 cm	133 cm	118 cm	1

DRABINA TELESKOPOWA

Faradome

to wielofunkcyjna, aluminiowa drabina teleskopowa do różnych zastosowań, jako drabina wolnostojąca, przystawna i z możliwością ustawiania na nierównym podłożu, również na schodach i podestach.





Przemysłana konstrukcja daje możliwość złożenia jej przez co zajmuje niewiele miejsca i jest łatwa do przemieszczania. Dzięki wygiętym dolnym podłużnicom, zakończonym antypoślizgowymi stopkami, drabina gwarantuje stabilność i komfort użytkowania.

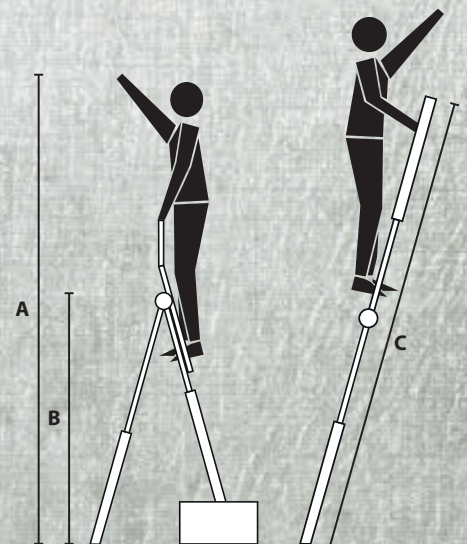

 O SZCZEGÓŁY I DOSTĘPNOŚĆ ZAPYTAJ HANDLOWCĘ W TWOIM REGIONIE



DRABINA TELESKOPOWA

NUMER KATALOGOWY				A	B	C	
TELES.T4S	13,5 kg	150 kg	8+8	358 cm	212 cm	420 cm	1
TELES.T5S	15,5 kg	150 kg	10+10	388 cm	240 cm	470 cm	1



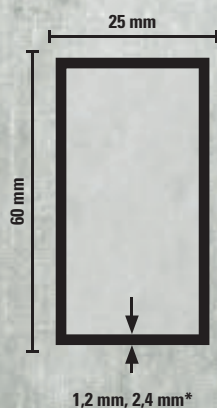
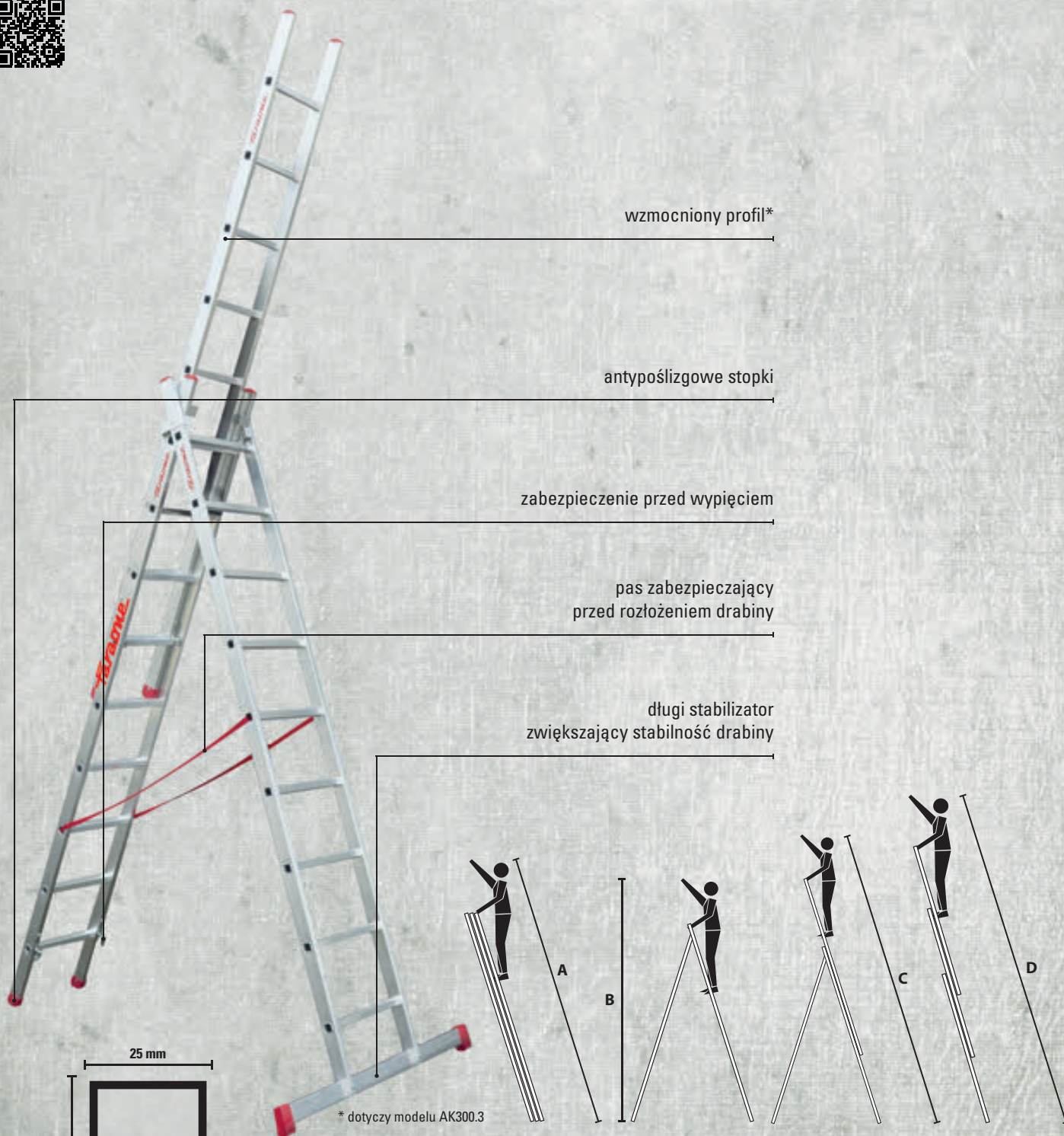

DRABINA WIELOFUNKCYJNA

Faraone

to wielofunkcyjna i maksymalnie bezpieczna drabina przeznaczona zarówno do prac remontowo-budowlanych jak i wielu innych. Doskonale sprawdzi się w przypadku użytkowników profesjonalnych podczas codziennej eksploatacji. Wielofunkcyjność drabin AK polega na szerokich możliwościach ich zastosowania: jako drabiny przystawne, rozsuwane trzelementowe, wolnostojące. Można je również rozdzielić na dwie niezależne drabiny: jedna dwuelementowa i druga jednoelementowa.



DRABINA WIELOFUNKCYJNA

NUMER KATALOGOWY				A	B	C	D	
AK225.3	13 kg	150 kg	3x7	345 cm	330 cm	400 cm	530 cm	1
AK250.3	15 kg	150 kg	3x8	370 cm	360 cm	500 cm	619 cm	1
AK280.3	18 kg	150 kg	3x9	400 cm	390 cm	520 cm	675 cm	1
AK300.3	21 kg	150 kg	3x10	420 cm	410 cm	550 cm	718 cm	1

PODEST ROBOCZY

Faradome

to bezpieczny i funkcjonalny podest, służący do wykonywania na przykład prac magazynowych, serwisowych, budowlanych, elektrycznych i konserwacyjnych. Posiada podest o regulowanej wysokości. Kąt wchodzenia wynosi 70 stopni. Posiada podnoszoną barierkę ochronną, zamontowaną na wysokości 110 cm. Platforma robocza posiada burty, dzięki którym nie ma możliwości osunięcia się w dół nogi użytkownika stojącego na niej. Podest jest łatwy w obsłudze. Jest składany, więc nie zajmuje dużo miejsca, a zamontowane koła usprawniają i ułatwiają jego transport.



praktyczna kieszonka na narzędzia



15 cm burta zapobiegająca przypadkowemu zsunięciu się nogi

ergonomiczny uchwyt do blokowania drabiny

rozsuwana część umożliwiająca postawienie drabiny np. na schodach

wygięte podłużnice zwiększające stabilność

kółka ułatwiające przemieszczanie drabiny

poprzeczki wzmocniające w narożnikach

antypoślizgowe stopki



O SZCZEGÓŁY I DOSTĘPNOŚĆ
ZAPYTAJ HANDLOWCĘ W TWOIM REGIONIE



PODEST ROBOCZY

NUMER KATALOGOWY				A	B	C	D	
PLS3	26 kg	150 kg	3	310 cm	80/130 cm	110 cm	132/175 cm	1
PLS5	32 kg	150 kg	5	418 cm	130/238 cm	110 cm	175/234 cm	1

PLATFORMA DLA TYNKARZY

Faraone

przeznaczona jest do robót tynkarskich, malarskich, wykonana z aluminium. Umożliwia przemieszczanie się wzdłuż ściany podczas pracy. Najwyższy stopień jest wykonany z kraty ortofoalowej (GRP), dzięki czemu nie zbierają się na jego powierzchni zanieczyszczenia. Sama krata jest lżejsza od stalowej i odporna na korozję. Stopień posiada ranty, które ułatwiają użytkowanie. Produkt posiada antypoślizgowe stopy i haki pozwalające na zawieszenie np. wiadra.

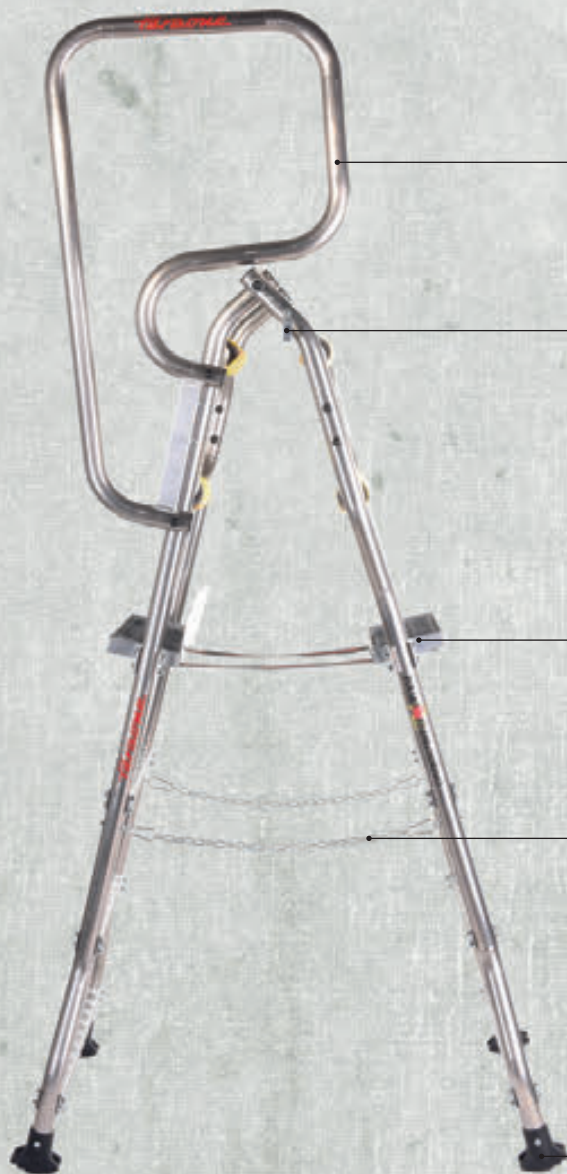

barierka chroniąca przed upadkiem

haki do zawieszania np. wiadra

stopnie z rantami
ułatwiającymi przemieszczanie się

łańcuch zabezpieczający
przed rozłożeniem drabiny

antypoślizgowe stopki



O SZCZEGÓŁY I DOSTĘPNOŚĆ
ZAPYTAJ HANDLOWCĘ W TWOIM REGIONIE

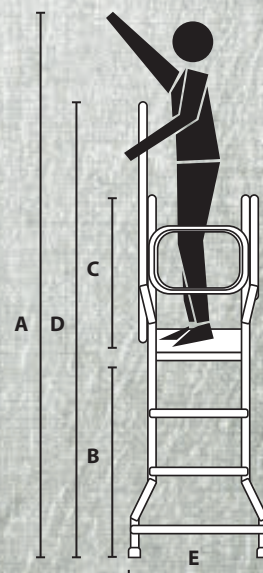

PLATFORMA DLA TYNKARZY

NUMER KATALOGOWY	16 kg	MAX 150 kg	4	A	B	C	D	E	1
PPP4	16 kg	150 kg	4	298 cm	98 cm	65 cm	210 cm	67 cm	1
PPP5	18 kg	150 kg	5	325 cm	125 cm	65 cm	240 cm	67 cm	1
BR.PPP	poręcz standard dla modelu PP5								

MINIRUSZTOWANIE

Faraone

idealnie sprawdzi się podczas wykonywania elewacji lub izolacji termicznej budynku. Stanowi niezbędny element każdego gospodarstwa domowego, jak również obowiązkowe wyposażenie na budowach. Jest

ono stosunkowo lekkie i niezwykle proste w montażu. Z łatwością przetransportujesz je na miejsce budowy bez nadmiernej utraty czasu na jego złożenie. Dzięki zastosowaniu aluminium, rusztowanie chronione jest przed korozją w wyniku działania czynników atmosferycznych. Zamontowane kółka ułatwiają przesuwanie rusztowania.



O SZCZEGÓŁY I DOSTĘPNOŚĆ
ZAPYTAJ HANDLOWCĘ W TWOIM REGIONIE

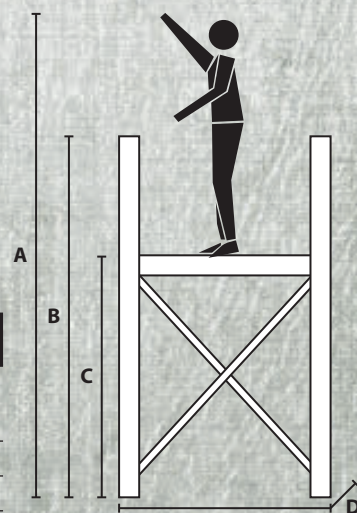

MINIRUSZTOWANIE

NUMER KATALOGOWY	16 kg	100 kg		A	B	C	D	E	
AK200	16 kg	100 kg	7	300 cm	200 cm	100 cm	60 cm	140 cm	1
AK400	48 kg	100 kg	14	500 cm	400 cm	300 cm	60 cm	140 cm	1



motive
Jakość ma znaczenie

KOZIOŁEK DRWENIANY

Wooden folding trestle • Деревянные козлы • Klappbock
• Banc [capra] de lucru din lemn

NUMER
KATALOGOWY

MAX
kg



090 011

120 kg

70 cm

79 cm

1/30



motive
Jakość ma znaczenie

DRABINA DREWNIANA

Wooden ladder • Лестница деревянная • Holzleiter • Scara dubla din lemn

NUMER
KATALOGOWY

MAX
kg



090 354

150 kg

4

120 cm

1/3

090 355

150 kg

5

145 cm

1/2

090 356

150 kg

6

172 cm

1

090 357

150 kg

7

200 cm

1



DRABINA ALUMINIOWA - JEDNOSTRONNA

Single-sided aluminium platform step ladders • Односторонняя бытовая алюминиевая стремянка • Einseitige Klappleiter • Scară unilaterală



Maksymalne obciążenie:

nośność do 150 kg

Zgodność z europejską normą:

EN 131

- Lekka i wygodna w przechowywaniu oraz transporcie
- Duży bezpieczny podest roboczy o wymiarach 25 cm x 25 cm
- Bezpieczne stopki z tworzywa sztucznego oraz dodatkowe zabezpieczenia stopni
- Szerokie, antypoślizgowe i karbowane stopnie



Tabela przedstawia parametry poszczególnych drabin z tej kategorii:



Numer katalogowy	Ilość stopni:	Masa:	A	B	C	G	H
120 043	1x3	3 kg	0,12 m	1,26 m	0,4 m	0,56 m	2,56 m
120 044	1x4	3,2 kg	0,12 m	1,5 m	0,43 m	0,78 m	2,78 m
120 045	1x5	3,6 kg	0,12 m	1,73 m	0,45 m	1 m	3 m
120 046	1x6	5,2 kg	0,12 m	1,97 m	0,48 m	1,22 m	3,22 m
120 047	1x7	6,9 kg	0,12 m	2,2m	0,5 m	1,45 m	3,45 m
120 048	1x8	7,4 kg	0,12 m	2,37 m	0,52 m	1,62 m	3,62 m

**DRABINA ALUMINIOWA - JEDNOSTRONNA**

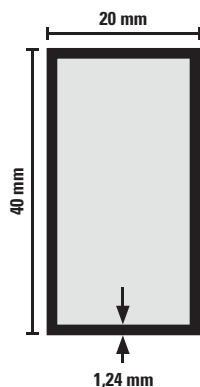
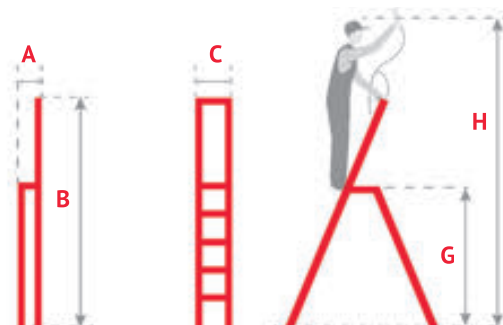
Single-sided aluminium platform step ladders • Односторонняя бытовая алюминиевая стремянка • Einseitige Klappleiter • Scară unilaterală

DOMO**Maksymalne obciążenie:**

nośność do 125 kg

- ✓ Lekka i wygodna w przechowywaniu oraz transporcie
- ✓ Duży bezpieczny podest roboczy o wymiarach 25 cm x 25 cm
- ✓ Bezpieczne stopki z tworzywa sztucznego oraz dodatkowe zabezpieczenia stopni
- ✓ Szerokie, antypoślizgowe i karbowane stopnie



Tabela przedstawia parametry poszczególnych drabin z tej kategorii:



Numer katalogowy	Ilość stopni:	Masa:	A	B	C	G	H
120 001	1x3	2,5 kg	0,12 m	1,26 m	0,4 m	0,56 m	2,56 m
120 002	1x4	2,9 kg	0,12 m	1,5 m	0,43 m	0,78 m	2,78 m
120 003	1x5	3,3 kg	0,12 m	1,73 m	0,45 m	1 m	3 m
120 004	1x6	4,6 kg	0,12 m	1,97 m	0,48 m	1,22 m	3,22 m
120 005	1x7	5,1 kg	0,12 m	2,2m	0,5 m	1,45 m	3,45 m
120 006	1x8	5,8 kg	0,12 m	2,37 m	0,52 m	1,62 m	3,62 m

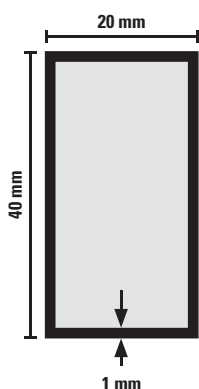
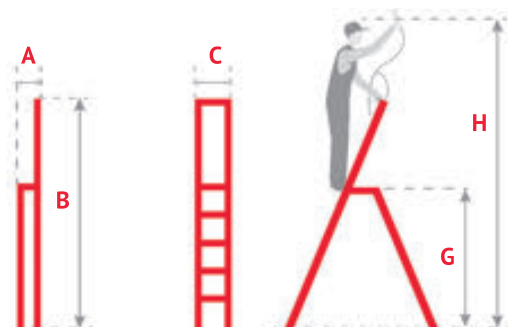

DRABINA ALUMINIOWA - DWUSTRONNA

Double-sided aluminium step ladders • Двухсторонняя бытовая алюминиевая стремянка • Doppelseitige Klappleiter • Scară cu două fețe



Maksymalne obciążenie:

do 150 kg

Zgodność z europejską normą:

- EN 14183 (modele 2x2)
- EN 131 (modele od 2x3 do 2x8)

- Mocne podłużnice ze specjalnego stopu aluminium zakończone plastikowymi stopkami antypoślizgowymi
- Szerokie karbowane stopnie przynitowane do podłużnic oraz zabezpieczone osłonkami z tworzywa sztucznego
- Specjalne taśmy zabezpieczające drabinę przed nadmiernym rozsunięciem

Wysokiej jakości drabinki dwustronne to produkt przeznaczony do pracy codziennej w pracy, w firmie oraz gospodarstwie domowym. Cechuje go wysoka jakość oraz obciążenie do 150 kg.



Tabela przedstawia parametry poszczególnych drabin z tej kategorii:



Numer katalogowy	Ilość stopni:	Masa:	A	B	C	G	H
120 014	2x2	1,85 kg	0,2 m	0,43 m	0,41 m	0,38 m	2,38 m
120 015	2x3	2,6 kg	0,2 m	0,67 m	0,43 m	0,61 m	2,61 m
120 016	2x4	3 kg	0,2 m	0,89 m	0,45 m	0,81 m	2,81 m
120 052	2x5	3,4 kg	0,2 m	1,14 m	0,47 m	1,03 m	3,03 m
120 053	2x6	4,1 kg	0,2 m	1,35 m	0,5 m	1,24 m	3,24 m
120 054	2x7	7,1 kg	0,2 m	1,57 m	0,52 m	1,46 m	3,46 m
120 055	2x8	8,3 kg	0,2 m	1,82 m	0,53 m	1,7 m	3,7 m

**DRABINA ALUMINIOWA - DWUSTRONNA**

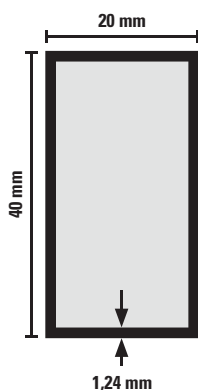
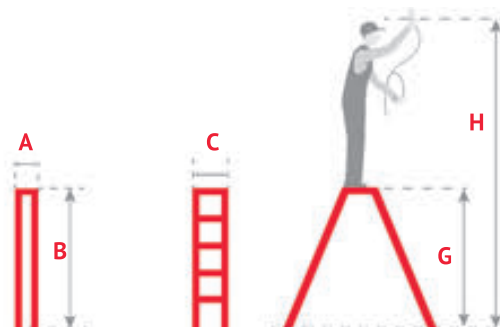
Double-sided aluminium step ladders • Двухсторонняя бытовая алюминиевая стремянка • Doppelseitige Klappleiter • Scară cu două fețe

DOMO**Maksymalne obciążenie:**

do 125 kg



- ✓ Lekka, poręczna, bardzo wygodna w przechowywaniu oraz transporcie
- ✓ Szerokie antypoślizgowe stopnie aluminiowe
- ✓ Stopnie nitowane oraz dodatkowo osłonięte w miejscu nitowania plastikowymi osłonkami
- ✓ Najwyższej jakości aluminium polskiej produkcji, zapewnia jej wieloletnią żywotność

Aluminiowa drabina dwustronna idealnie sprawdza się w użytkowaniu na co dzień oraz do prac remontowo budowlanych w domu.



Tabela przedstawia parametry poszczególnych drabin z tej kategorii:



Numer katalogowy	Ilość stopni:	Masa:	A	B	C	G	H
120 007	2x2	1,7 kg	0,2 m	0,43 m	0,41 m	0,38 m	2,38 m
120 008	2x3	2,1 kg	0,2 m	0,67 m	0,43 m	0,61 m	2,61 m
120 009	2x4	3 kg	0,2 m	0,89 m	0,45 m	0,81 m	2,81 m
120 010	2x5	3,4 kg	0,2 m	1,14 m	0,47 m	1,03 m	3,03 m
120 011	2x6	4,1 kg	0,2 m	1,35 m	0,5 m	1,24 m	3,24 m
120 012	2x7	7,1 kg	0,2 m	1,57 m	0,52 m	1,46 m	3,46 m
120 013	2x8	8,3 kg	0,2 m	1,82 m	0,53 m	1,7 m	3,7 m

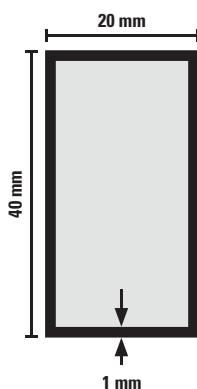
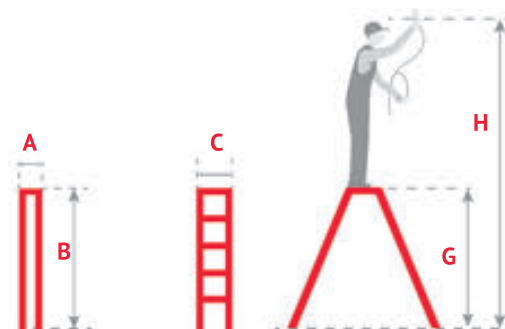

PODEST ROBOCZY

Working platform • Рабочая платформа • Arbeitsplattform • Platforma de lucru



Maksymalne obciążenie:

do 150 kg

Zgodność z europejską normą:

EN 131

- Wodoodporna, antypoślizgowa platforma
- Szybkie składanie
- Niewielkie wymiary po złożeniu
- Antypoślizgowe stopki
- Malowane proszkowo podłużnice



Składane nóżki dla łatwiejszego przechowywania



Bezpieczna blokada uniemożliwiająca niekontrolowane zamknięcie się drabiny

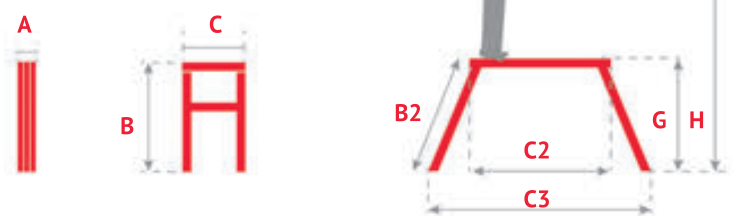

Parametry podestu roboczego

Numer katalogowy	Ilość szczebli:	Masa:	A	B	C	B2	C2	C3	G	H
120 104	1x4	7 kg	0,10 m	0,30 m	0,40 m	0,32 m	0,87 m	1,09 m	0,30 m	2,30 m
120 105	1x5	8,2 kg	0,10 m	0,30 m	0,40 m	0,32 m	1,15 m	1,37 m	0,30 m	2,30 m
120 124	2x4	7,3 kg	0,25 m	0,56 m	0,40 m	0,60 m	0,87 m	1,28 m	0,56 m	2,56 m
120 125	2x5	9,2 kg	0,25 m	0,56 m	0,40 m	0,60 m	1,15 m	1,56 m	0,56 m	2,56 m



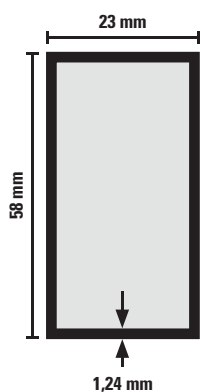

DRABINA ALUMINIOWA PRZYSTAWNA

Leaning aluminium ladders • Регулируемая алюминиевая лестница
• Anlehnbare Aluminiumleitern



Maksymalne obciążenie:

do 150 kg

Zgodność z europejską normą:

EN 131

- ✓ Łączenie szczebli odbywa się metodą zagniatania
- ✓ Szerokie szczeble posiadają odpowiednie ryflowanie w celu zapewnienia dodatkowej stabilności o szerokości 25 mm x 25 mm
- ✓ Mocna stabilna konstrukcja gwarantuje bezpieczeństwo pracy na wysokościach
- ✓ Stopki antypoślizgowe, zabezpieczają drabinę przed przesunięciem
- ✓ Aluminium odporne na warunki atmosferyczne

Profesjonalna aluminiowa drabina przystawna, z której korzysta tysiące specjalistów w branży. Parametry drabiny dobrane są tak, by sprawdzić się w pracach na dużych wysokościach.



Tabela przedstawia parametry poszczególnych drabin z tej kategorii:

Numer katalogowy	Ilość szczebli:	Masa:	A	B	C	G	H
120 075	1x5	2,2 kg	5 cm	1,4 m	0,42 m	0,44 m	2,44 m
120 076	1x6	2,7 kg	5 cm	1,66 m	0,4 m	0,67 m	2,67 m
120 077	1x7	3,1 kg	5 cm	1,92 m	0,4 m	0,92 m	2,92 m
120 078	1x8	3,5 kg	5 cm	2,18 m	0,4 m	1,18 m	3,18 m
120 079	1x9	3,85 kg	5 cm	2,44 m	0,4 m	1,43 m	3,43 m
120 080	1x10	4,3 kg	5 cm	2,72 m	0,4 m	1,68 m	3,68 m
120 081	1x11	4,8 kg	5 cm	2,98 m	0,4 m	1,93 m	3,93 m
120 082	1x12	5,1 kg	5,8 m	3,26 m	0,95 m	2,18 m	4,18 m
120 083	1x13	5,5 kg	5,8 cm	3,45 m	0,95 m	2,45 m	4,45 m
120 084	1x14	5,9 kg	5,8 cm	3,71 m	0,95 m	2,71 m	4,71 m

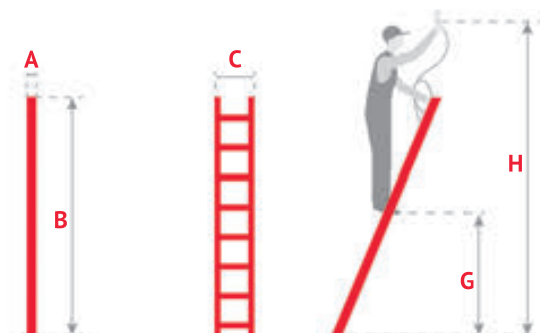

DRABINA ALUMINIOWA PRZYSTAWNA

Leaning aluminium ladders • Регулируемая алюминиевая лестница
• Anlehnbare Aluminiumleitern

BASIC

Maksymalne obciążenie:

do 150 kg

Zgodność z europejską normą:

EN 131

- Łączenie szczebli odbywa się metodą zagniatania
- Szerokie szczeble posiadają odpowiednie ryflowanie w celu zapewnienia dodatkowej stabilności o szerokości 25 mm x 25 mm
- Mocna stabilna konstrukcja gwarantuje bezpieczeństwo pracy na wysokościach
- Stopki antypoślizgowe, zabezpieczają drabinę przed przesunięciem
- Aluminium odporne na warunki atmosferyczne

Profesjonalna aluminiowa drabina przystawna, z której korzysta tysiące specjalistów w branży. Parametry drabiny dobrane są tak, by sprawdzić się w pracach na dużych wysokościach.



Tabela przedstawia parametry poszczególnych drabin z tej kategorii:



Numer katalogowy	Ilość szczebli:	Masa:	A	B	C	G	H
120 086	1x6	2,7 kg	5 cm	1,66 m	0,4 m	0,67 m	2,67 m
120 087	1x7	3,1 kg	5 cm	1,92 m	0,4 m	0,92 m	2,92 m
120 088	1x8	3,5 kg	5 cm	2,18 m	0,4 m	1,18 m	3,18 m
120 089	1x9	3,85 kg	5 cm	2,44 m	0,4 m	1,43 m	3,43 m
120 090	1x10	4,3 kg	5 cm	2,72 m	0,4 m	1,68 m	3,68 m
120 091	1x11	4,8 kg	5 cm	2,98 m	0,4 m	1,93 m	3,93 m

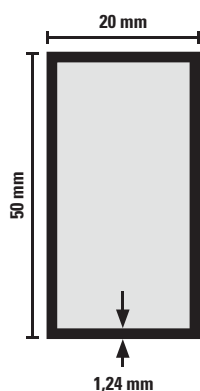
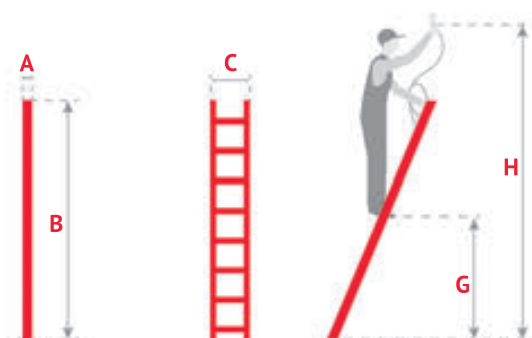

DRABINY WIELOFUNKCYJNE - DWUELEMENTOWE

Drabina o szerokich parametrach użytkowania, sprawdzi się jako drabina rozkładana oraz rozsuwana. Świetne zestawienie jakości do ceny oraz wytrzymałości. Przeznaczona do profesjonalnej pracy przede wszystkim na dużych wysokościach. Idealne połączenie jakości do ceny oraz wytrzymałości. Produkty posiadają mocne i szerokie podłużnice o wymiarze 58 x 23 cm



Szeroki stabilizator poprzeczny, jako niezbędny element konstrukcyjny drabiny chroniący ją przed upadkiem bocznym



Haki zabezpieczające (zapadkowe) to system blokowania elementu drabiny i zabezpieczenia go przed niezamierzonym wypięciem



Dzięki odpowiednio zaprojektowanej konstrukcji prowadnic odpowiadają one za prawidłowe rozstawianie i rozsuwanie drabiny



DRABINA ALUMINIOWA WIELOFUNKCYJNA - DWUELEMENTOWA

Double 3-Way Combination Ladder • 2x секционная алюминиевая лестница
• Aluminium-Multifunktionsleiter 2x • Scară dubla



Maksymalne obciążenie:

do 150 kg

Zgodność z europejską normą:

EN 131

- Szerokie szczeble posiadają odpowiednie ryflowanie w celu zapewnienia dodatkowej stabilności o szerokości 25 mm x 25 mm
- Łączenie szczebli odbywa się metodą zagniatania
- Stopki antypoślizgowe, zabezpieczają drabinę przed przesunięciem
- Mocna stabilna konstrukcja gwarantuje bezpieczeństwo pracy na wysokościach
- Aluminium odporne na warunki atmosferyczne



Tabela przedstawia parametry poszczególnych drabin z tej kategorii:



Numer katalogowy	Ilość szczebli:	Masa:	A	B	C1	C2	E	F	G	H
120 066	2x6	7 kg	0,11 m	1,65 m	0,47 m	0,95 m	2,19 m	3,26 m	0,95 m	2,95 m
120 067	2x7	7,3 kg	0,11 m	1,91 m	0,47 m	0,95 m	2,96 m	3,99 m	1,2 m	3,19 m
120 068	2x8	8,2 kg	0,11 m	2,17 m	0,47 m	0,95 m	3,5 m	4,33 m	1,45 m	3,45 m
120 069	2x9	9,2 kg	0,11 m	2,43 m	0,47 m	0,95 m	3,75 m	4,75 m	1,71 m	3,71 m
120 070	2x10	10 kg	0,11 m	2,7 m	0,47 m	0,95 m	4,03 m	5,12 m	1,98 m	3,98 m
120 071	2x11	10,7 kg	0,11 m	2,97 m	0,47 m	0,95 m	4,55 m	5,49 m	2,2 m	4,2 m
120 072	2x12	12 kg	0,11 m	3,24 m	0,47 m	1 m	4,91 m	5,86 m	2,45 m	4,45 m

**DRABINA ALUMINIOWA WIELOFUNKCYJNA-TRÓJELEMENTOWA**Triple 3-Way Combination Ladder • 3x секционная алюминиевая лестница
• Aluminium-Multifunktionsleiter 3x • Scară tripla**motive**
Jakość ma znaczenie**Maksymalne obciążenie:**

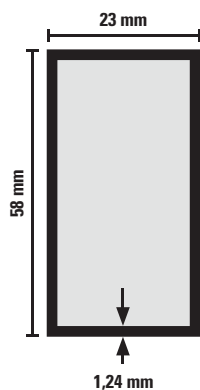
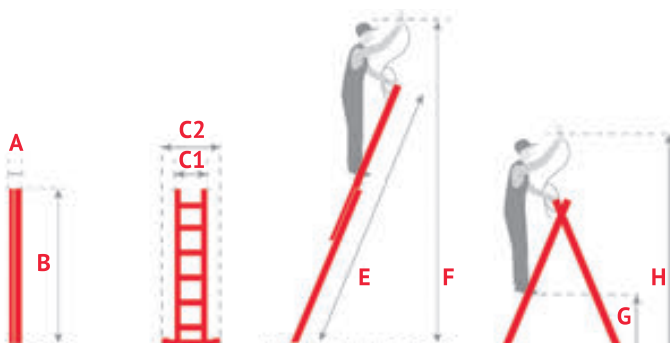
do 150 kg

Zgodność z europejską normą:

EN 131



Tabela przedstawia parametry poszczególnych drabin z tej kategorii:



Numer katalogowy	Ilość szczebli:	Masa:	A	B	C	D	D2	E	F	G	H	I	J
120 306	3x6	9,6 kg	0,15 m	1,65 m	0,95 m	2,45 m	2,96 m	0,95 m	2,95 m	0,95 m	2,95 m	1,69 m	3,69 m
120 020	3x7	10,7 kg	0,15 m	1,91 m	0,95 m	2,7 m	3,76 m	1,45 m	3,45 m	1,2 m	3,2 m	2,59 m	4,59 m
120 021	3x8	12,2 kg	0,15 m	2,17 m	0,95 m	3,5 m	4,55 m	1,96 m	3,96 m	1,45 m	3,45 m	3,53 m	5,53 m
120 022	3x9	14,4 kg	0,15 m	2,43 m	0,95 m	3,75 m	5,12 m	2,21 m	4,21 m	1,7 m	3,7 m	4,03 m	6,03 m
120 023	3x10	14,8 kg	0,15 m	2,7 m	0,95 m	4,03 m	5,37 m	2,75 m	4,75 m	1,98 m	3,98 m	4,28 m	6,28 m
120 024	3x11	16 kg	0,15 m	2,97 m	0,95 m	4,55 m	5,62 m	3,24 m	5,24 m	2,2 m	4,2 m	4,52 m	6,52 m
120 312	3x12	21 kg	0,185 m	3,17 m	1,1 m	5,3 m	7,15 m	3,85 m	5,85 m	2,35 m	4,35 m	6 m	8 m
120 313	3x13	22,5 kg	0,185 m	3,44 m	1,1 m	5,85 m	7,95 m	4,35 m	6,33 m	2,6 m	4,6 m	6,75 m	8,75 m
120 314	3x14	25 kg	0,185 m	3,7 m	1,2 m	6,35 m	8,75 m	4,6 m	6,6 m	2,85 m	4,85 m	7,52 m	9,5 m
120 315	3x15	28 kg	0,185 m	3,95 m	1,2 m	7,15 m	10,3 m	5,25 m	7,2 m	3,1 m	5,1 m	8,75 m	10,7 m

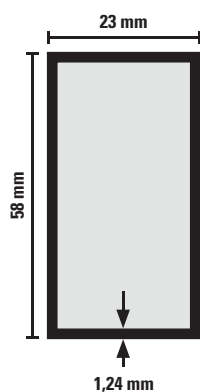
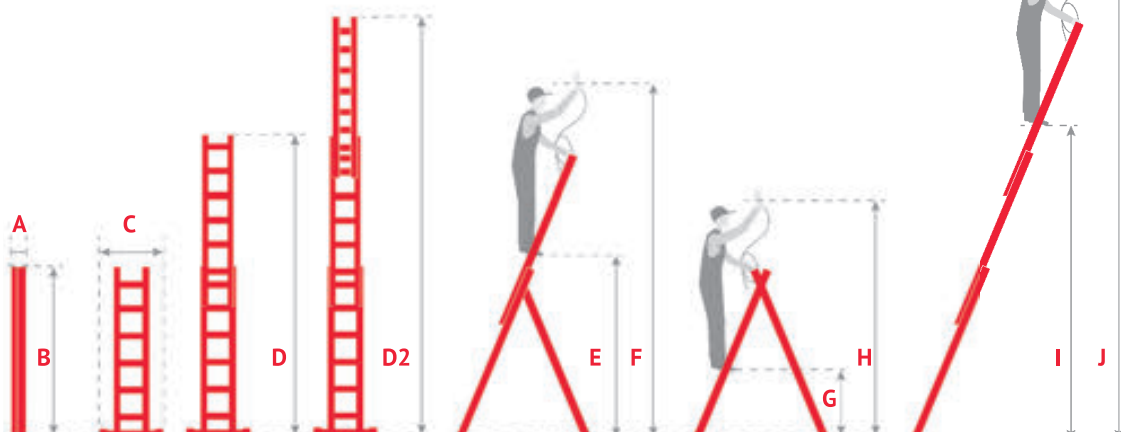

DRABINA ALUMINIOWA WIELOFUNKCYJNA-TRÓJELEMENTOWA

Triple 3-Way Combination Ladder • 3x секционная алюминиевая лестница
• Aluminium-Multifunktionsleiter 3x • Scară tripla

BASIC

Maksymalne obciążenie:

do 150 kg

Zgodność z europejską normą:

EN 131

- Szerokie szczeble posiadają odpowiednie ryflowanie w celu zapewnienia dodatkowej stabilności o szerokości 25 mm x 25 mm
- Łączenie szczebli odbywa się metodą zagniatania
- Stopki antypoślizgowe, zabezpieczają drabinę przed przesunięciem
- Mocna stabilna konstrukcja gwarantuje bezpieczeństwo pracy na wysokościach
- Aluminium odporne na warunki atmosferyczne



Drabina o szerokich parametrach użytkowania, sprawdzi się jako drabina przystawna, rozkładana oraz rozsuwana. Przeznaczona do profesjonalnej pracy przede wszystkim na dużych wysokościach. Idealne połączenie jakości do ceny oraz wytrzymałości. Produkty posiadają mocne i szerokie podłużnice o wymiarze 50 x 20 centymetrów

Szeroki stabilizator poprzeczny, jako niezbędny element konstrukcyjny drabiny chroniący ją przed upadkiem bocznym



Tabela przedstawia parametry poszczególnych drabin z tej kategorii:



Numer katalogowy	Ilość szczebli:	Masa:	A	B	C	D	D2	E	F	G	H	I	J
120 017	3x6	9,6 kg	0,15 m	1,65 m	0,95 m	2,45 m	2,96 m	0,95 m	2,95 m	0,95 m	2,95 m	1,69 m	3,69 m
120 018	3x7	10,7 kg	0,15 m	1,91 m	0,95 m	2,7 m	3,76 m	1,45 m	3,45 m	1,2 m	3,2 m	2,59 m	4,59 m
120 058	3x8	14,4 kg	0,15 m	2,17 m	0,95 m	3,5 m	4,55 m	1,96 m	3,96 m	1,45 m	3,45 m	3,53 m	5,53 m
120 019	3x9	14,4 kg	0,15 m	2,43 m	0,95 m	3,75 m	5,12 m	2,21 m	4,21 m	1,7 m	3,7 m	4,03 m	6,03 m

**WIELOZADANIOWY PODEST ALUMINIOWY
Z PLATFORMĄ** rusztowanie / drabina przystawna /
drabina wolnostojąca4 - function scaffolding ladder with platform • Лестница-помост алюминиевая
• 4- Funktion Gerustleiter mit Plattform • Scară si schela cu platforma**motive**
Jakość ma znaczenie**Maksymalne obciążenie:**

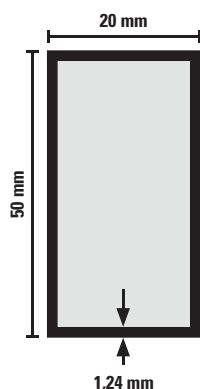
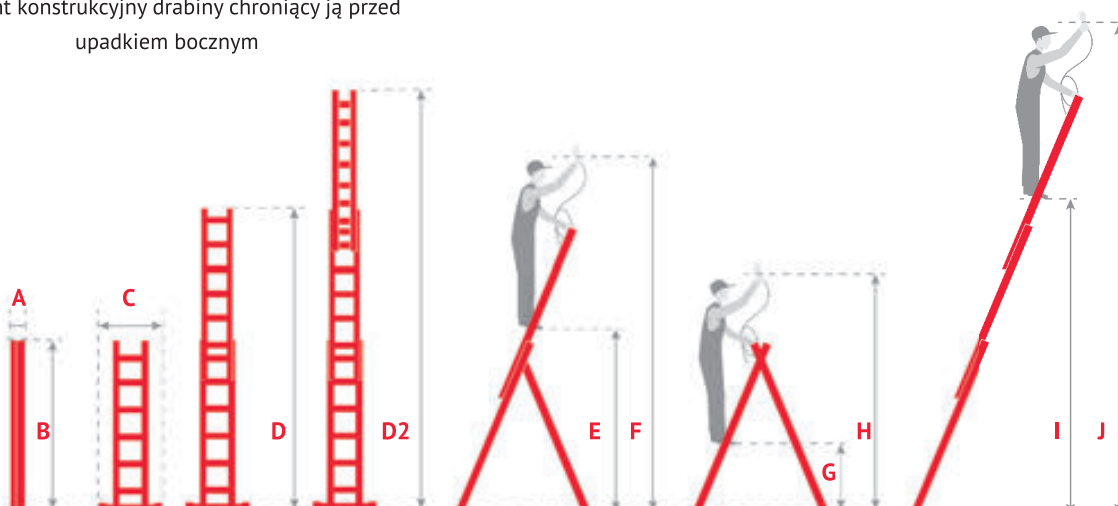
8 do 150 kg

Zgodność z europejską normą:

✓ EN 131

- ✓ Aluminiowe drabino - rusztowanie montażowe przeznaczone do lekkich prac na wysokościach
- ✓ Uniwersalna, lekka konstrukcja
- ✓ Podest o wymiarach 114 x 33 cm
- ✓ Barierka BHP
- ✓ Platforma antypoślizgowa + 2 stalowe wsporniki platformy
- ✓ Urządzenie typu 3 w 1 (mini rusztowanie, drabina przystawna i drabina wolnostojąca)
- ✓ Wymiary po złożeniu do transportu:
Dla modelu 2x6: 46x14x164 cm
Dla modelu 2x7: 46x14x188 cm
Dla modelu 2x8: 46x14x215 cm

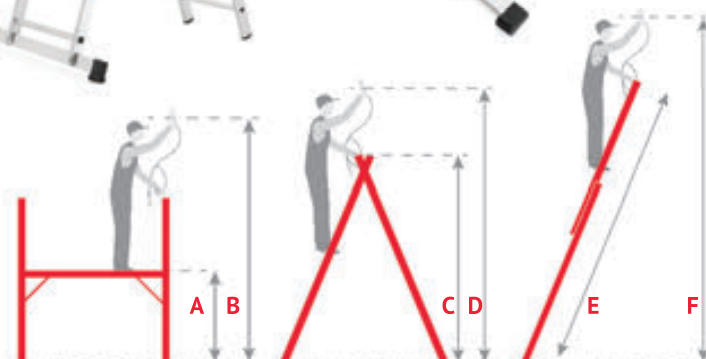
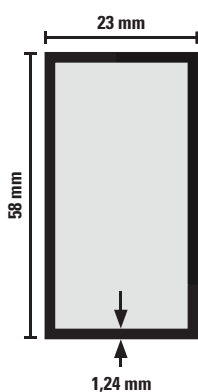
Tabela przedstawia
parametry poszczególnych
rusztowań z tej kategorii

Numer katalogowy	Ilość szczebli:	Masa:	A	B	C	D	E	F
120 030	2x6	11,5 kg	0,96 m	2,96 m	1,53 m	2,83 m	2,38 m	3,68 m
120 031	2x7	12 kg	0,96 m	2,96 m	1,85 m	2,95 m	2,93 m	4,2 m
120 032	2x8	21 kg	0,96 m	2,96 m	2,03 m	3,33 m	3,42 m	4,72 m



DRABINY PRZEGUBOWE

Drabina aluminiowa przegubowa 4x3 z podestem - to najbardziej uniwersalna drabina dostępna na naszym rynku. Drabina może być używana jako podest roboczy (podest antypoślizgowy w zestawie), drabina wolnostojąca oraz jako drabina przystawna. Największą zaletą drabiny jest jej wielofunkcyjność oraz kompaktowe rozmiary po złożeniu.



Podest ze sklejki antypoślizgowej

**DRABINA PRZEGUBOWA**Multi purpose ladder • Универсальная лестница • Mehrzweckleiter
• Scară articulată**motive**
Jakość ma znaczenie**Maksymalne obciążenie:**

do 150 kg

Zgodność z europejską normą:

EN 131

- Mocne podłużnice aluminiowe o rozmiarze 60 x 25 mm
- Samoblokujące się zawiasy, umożliwiające pracę w każdej konfiguracji rozłożenia drabiny
- Antypoślizgowe, ryflowane szczeble, podnoszą stabilność konstrukcji
- Szczeble łączone z pobocznicą metodą tłoczenia
- Wielofunkcyjność: 4 różne warianty ułożenia
- 2 szerokie stabilizatory



Mocne stalowe przeguby które umożliwiają płynne i szybkie zmienianie pozycji drabiny



Drabina wyposażona jest w dwa stabilizatory zapewniające bezpieczną pracę



Tabela przedstawia parametry poszczególnych drabin z tej kategorii:



Numer katalogowy	Ilość szczebli:	Masa:	A	B	C	D	E
120 026	4x3	10 kg	-	1,70 m	3 m	3,40 m	4,40 m
120 027	4x3 z podestem	12 kg	2,95 m	1,70 m	3 m	3,40 m	4,40 m
120 028	4x4	12,5 kg	-	2,2 m	3,5 m	4,45 m	5,45 m
120 029	4x4 z podestem	14,5 kg	-	2,2 m	3,5 m	4,45 m	5,45 m

ARTYKUŁY OGRODNICZE

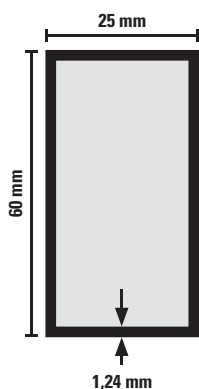
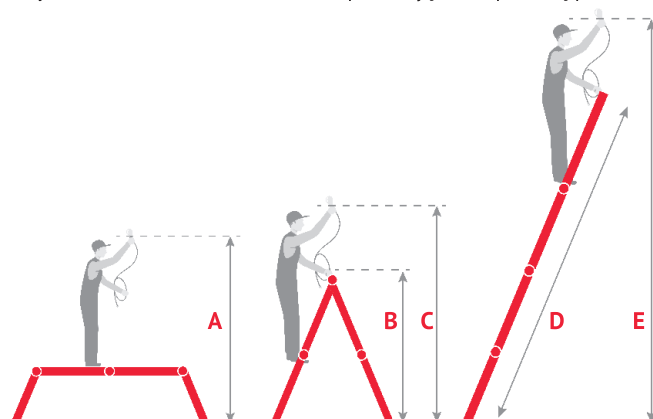
GARDENING EQUIPMENT • ИНСТРУМЕНТЫ ДЛЯ САДА И ОГОРОДА • GARTENWERKZEUGE
• UNELTE PENTRU GRADINA





WĄŻ OGRODOWY BOS PLUS

Garden Hose "BOS PLUS" • Садовый шланг "BOS PLUS"
• Gartenschlauch "BOS PLUS" • Furtun de gradina Bos Plus

NUMER KATALOGOWY			
100 600	1/2"	20 m	1
100 601	3/4"	20 m	1



WĄŻ OGRODOWY CARBON PLUS

Garden Hose "CARBON PLUS" • Садовый шланг "CARBON PLUS"
• Gartenschlauch "CARBON PLUS" • Furtun de gradina Carbon Plus

NUMER KATALOGOWY			
100 605	3/4"	20 m	1
100 606	1/2"	20 m	1



WĄŻ OGRODOWY ROZCIĄGLIWY

Expandable garden hose • Садовый шланг растягивающийся
• Flexibler Gartenschlauch • Furtun de gradina

NUMER KATALOGOWY		
100 610	5 - 20 m	1/12
100 611	7,5 - 30 m	1/8
100 612	10 - 40 m	1/8



WIESZAK ŚCIENNY NA WĄŻ

Garden hose hanger • Вешалка для садового шланга • Gartenschlauch Bügel

NUMER KATALOGOWY	
100 595	1/6



NIEZBĘDNIK OGRODOWY

Garden set • Набор: шланг, катушка, переходники, коннектор
• Gartenschlauch Bügel • Kit pentru irigatii

NUMER KATALOGOWY			
100 592	1/2"	20 m	1





ZWIJACZ DO WĘŻA OGRODOWEGO

Hose reel • Катушка для садового шланга • Aufroller für Gartenschlauch

NUMER
KATALOGOWY

100 630



1/6



SZYBKOZŁĄCZKA NA WĄŻ - AQUA STOP

Hose connector with water stop • Быстроразъемное соединение для шланга AQUA STOP • Schlauchverbinder AQUA STOP • Conector furtun AQUA STOP

NUMER
KATALOGOWY

100 501

100 503



1/2"

10

3/4"

10



SZYBKOZŁĄCZKA NA WĄŻ - COMFORT

Hose connector • Быстроразъемное соединение для шланга COMFORT • Schlauchverbinder COMFORT • Conector furtun COMFORT

NUMER
KATALOGOWY

100 502

100 504



1/2"

10

3/4"

10



SZYBKOZŁĄCZKA NA WĄŻ AGROCAL

Hose connector • Быстроразъемное соединение для шланга AGROCAL • Schlauchverbinder AGROCAL • Conector AGROCAL

NUMER
KATALOGOWY

100 505



1"

10



PRZYŁĄCZE NA KRAN Z GWINTEM WEWNĘTRZNYM

Threaded tap connector • Штуцер на кран с внутренней резьбой • Hahnverbinder • Conector robinet, filet interior

NUMER
KATALOGOWY

100 511

100 510



3/4"

25

1"

25



PRZYŁĄCZE NA KRAN Z GWINTEM ZEWNĘTRZNYM

Threaded tap connector (outside thread) • Штуцер с наружной резьбой
• Hahnanschluss mit Außengewinde • Conector robinet, filet exterior

NUMER KATALOGOWY		
100 512	1/2"	25
100 513	3/4"	25



PRZYŁĄCZE AGROCAL Z GWINTEM ZEWNĘTRZNYM



Threaded tap connector • Штуцер на кран с наружной резьбой
• Hahnverbinder • Conector robinet, filet interior

NUMER KATALOGOWY		
100 515	3/4" - 1"	10
100 514	1" - 1"	10



PRZYŁĄCZE AGROCAL Z GWINTEM WEWNĘTRZNYM

Threaded tap connector • Штуцер на кран с внутренней резьбой
• Hahnverbinder • Conector robinet, filet interior

NUMER KATALOGOWY		
100 516	1" - 1"	10
100 517	5/4"	10



PRZYŁĄCZE REDUKCYJNE

1" threaded tap connector with reducing connector 3/4" • Штуцер на кран с внутренней резьбой 1" • Anschluß für Wasserhahn mit Innengewinde 1"

NUMER KATALOGOWY		
100 518	1" - 3/4"	12



PRZYŁĄCZE NA KRAN Z GWINTEM WEWNĘTRZNYM

Threaded tap connector • Штуцер на кран с внутренней резьбой
• Hahnverbinder • Conector robinet, filet interior

NUMER KATALOGOWY		
100 519	1/2"	25





REDUKCJA PRZYŁĄCZA

Reducing connector • Переходник соединение • Redukce

NUMER KATALOGOWY		
100 521	1" → 3/4"	25
100 520	3/4" → 1/2"	25



ŁĄCZNIK DO WĘŻA

Hose connector • Соединитель для шланга • Reparatör • Conector 2 furtunuri

NUMER KATALOGOWY		
100 525	1/2"	10
100 526	3/4"	10



ŁĄCZNIK REDUKCYJNY SZYBKOZŁĄCZEK AGROCAL I STANDARD

Hose connector • Соединитель понижающий • Reparatör • Conector 2 furtunuri

NUMER KATALOGOWY		
100 527	AGROCAL → 1/2" - 3/4"	10



ŁĄCZNIK REDUKCYJNY

Hose connector • Соединитель понижающий с 1/2" на 3/4"
• Reparatör • Conector 2 furtunuri

NUMER KATALOGOWY		
100 528	1/2" - 3/4"	10



ŁĄCZNIK SZYBKOZŁĄCZEK

Double-ended hose connector • Соединитель быстроразъемных соединений
• Kupplung • Conector 2 cuple

NUMER KATALOGOWY		
100 529	1/2" - 3/4"	25



ŁĄCZNIK SZYBKOZŁĄCZEK AGROCAL

Double-ended hose connector • Соединитель быстроразъемных соединений
• Kupplung • Conector 2 cuple

NUMER
KATALOGOWY



100 530

1"

10



ŁĄCZNIK AGROCAL

Double-ended hose connector • Соединитель быстроразъемных соединений
• Kupplung • Conector 2 cuple

NUMER
KATALOGOWY



100 531

1"

10



ŁĄCZNIK REDUKCYJNY AGROCAL

Double-ended hose connector • Соединитель быстроразъемных соединений
• Kupplung • Conector 2 cuple

NUMER
KATALOGOWY



100 532

1" - 3/4"

10



TRÓJNIK

Y hose connector • Тройник • Y-Stück • Conector Y

NUMER
KATALOGOWY



100 535

3x1/2" - 3/4"

10



TRÓJNIK AGROCAL

Y hose connector • Тройник • Y-Stück • Conector Y

NUMER
KATALOGOWY



100 536

1"

10





TRÓJNIK REDUKCYJNY AGROCAL

Y hose connector • Тройник • Trišakis • Y-Stück • Conector Y

NUMER
KATALOGOWY

100 537



1" → 2x1/2"



10



TRÓJNIK Z DWOMA ZAWORAMI

2 way splitter • Тройник с двумя клапанами с резьбой 1" с переходом
штуцера • 2-Wege-Ventil • Conector robinet, 2 ramificatii cu robinet

NUMER
KATALOGOWY

100 538



1" → 2x3/4"



10



ROZDZIELACZ Z ZAWORAMI

4 way Tap connector with Valves • Присоединение - Распределитель
с клапанами • Anschluß - Verteiler mit Ventilen

NUMER
KATALOGOWY

100 539



3/4" → 1/2" - 3/4"



10



PISTOLET DO ZRASZANIA ERGO

Spray pistol Ergo • Пистолет для поливки Ergo • Bewässerungsbrause Ergo
• Pistol de stropit Ergo

NUMER
KATALOGOWY

100 540



1/2"



1/12/48



PISTOLET DO ZRASZANIA ERGO-SPEC

Spray pistol Ergo-Spec • Пистолет для поливки Ergo-Spec
• Bewässerungsbrause Ergo-Spec • Pistol de stropit Ergo-Spec

NUMER
KATALOGOWY

100 541



1/2"



1/48



PISTOLET DO ZRASZANIA WIELOFUNKCYJNY - PROFI

Spray pistol PROFI • Пистолет для поливки многофункциональный PROFI
• Bewässerungsbrause Profi • Pistol de stropit Profi

NUMER
KATALOGOWY



100 542

1/2"

1/12/48



PISTOLET ZRASZAJĄCY PROSTY

Spray pistol • Пистолет для поливки • Bewässerungsbrause • Pistol de stropit

NUMER
KATALOGOWY



100 543

1/2"

1



KOŃCÓWKA ZRASZAJĄCA

Hose spray nozzle • Наконечник поливочный • Schlauchspritze
• Duza de stropit

NUMER
KATALOGOWY



100 544

1/2"

1/10



KOŃCÓWKA ZRASZAJĄCA SITKO

Jet spray nozzle with strainer • Распылительный наконечник с ситом
• Sprühspitze mit Sieb

NUMER
KATALOGOWY



100 546

1/2"

12



KOŃCÓWKA ZRASZAJĄCA AGROCAL

Hose spray nozzle Agrocal • Наконечник поливочный Agrocal
• Schlauchspritze Agrocal • Duza de stropit Agrocal

NUMER
KATALOGOWY



100 545

1"

10





ZRASZACZ NA PODSTAWIE WBIJANEJ

Sprinkler on spike • Дождеватель на подставке устанавливаемой в грунт • Kreisregner • Aspensor circular, cu spin

NUMER
KATALOGOWY

100 556



1



ZRASZACZ PULSACYJNY BRAWO

Impulse sprinkler Brawo • Дождеватель импульсный пластиковый с запасными соплами Brawo • Impuls-, Kreis- und Sektorenregnerkop Brawo • Aspensor plastic, cu tarus Brawo

NUMER
KATALOGOWY

100 557



12



ZRASZACZ PULSACYJNY - PLASTIK

Impulse sprinkler • Дождеватель импульсный пластиковый с запасными соплами • Impuls-, Kreis- und Sektorenregnerkop • Aspensor plastic, cu tarus

NUMER
KATALOGOWY

RT 1340



1/30



ZRASZACZ OBROTOWY OMEGA WOLNOSTOJĄCY

Rotating sprinkler on stand • Дождеватель вращающийся на стоящей подставке • Drehsprinkler auf Stehgestell

NUMER
KATALOGOWY

100 551



1/12



ZRASZACZ OBROTOWY NA PODSTAWIE WBIJANEJ

Rotating sprinkler on spike • Дождеватель вращающийся на подставке устанавливаемой в грунт • Drehsprinkler auf Einschlaggestell

NUMER
KATALOGOWY

100 553



1/6/60



ZRASZACZ OBROTOWY WOLNOSTOJĄCY

Rotating sprinkler on stand • Дождеватель вращающийся на стоящей подставке • Drehsprinkler auf Stehgestel

NUMER
KATALOGOWY



100 552

1/20



ZRASZACZ WAHADŁOWY PLUS 15

Oscillating sprinkler • Дождеватель осциллирующий PLUS 15 сопел
• Viereckregner mit 15 Düsen • Aspensor, oscilant, raza reglabila

NUMER
KATALOGOWY



RT 1363

15 dysz

1/12



ZRASZACZ WAHADŁOWY COMBO 21

Oscillating sprinkler • Дождеватель осциллирующий COMBO 21 сопел
• Viereckregner mit 21 Düsen • Aspensor, oscilant, raza reglabila

NUMER
KATALOGOWY



RT 1368

21 dysz

1/12



ZRASZACZ WAHADŁOWY ELEGANCE

Oscillating sprinkler • Дождеватель осциллирующий ELEGANCE
• Viereckregner mit 17 Düsen • Aspensor, oscilant, raza reglabila

NUMER
KATALOGOWY



100 555

17 dysz

10



ZRASZACZ WAHADŁOWY ALUMINO

Oscillating sprinkler • Дождеватель осциллирующий Alumino
• Viereckregner Alumino • Aspensor, oscilant, raza reglabila

NUMER
KATALOGOWY



100 550

15 dysz

1/6/24





GRABKI

Small garden rakes • Грабли • Kleinfächerbesen • Minigrebla

NUMER
KATALOGOWY



100 570

55 cm

1



ŁOPATKA UNIWERSALNA

Garden trowel • Лопатка универсальная • Blumenkelle
• Scafa ingusta pentru flori

NUMER
KATALOGOWY



100 571

30 cm

1/20



MOTYCZKO-GRABKI

Dual-use hoe - cultivator • Культиватор - грабли • Doppelhacke • Sapaliga

NUMER
KATALOGOWY



100 572

32 cm

1/30



PAZURKI - KULTYWATOR

Cultivator • Когти - культиватор • Handgrubber • Cultivator pentru gradinarit

NUMER
KATALOGOWY



100 574

28 cm

1/20



WIDELKI

Fork • Вилка • Pflanzgabel • Mini-furca

NUMER
KATALOGOWY



100 581

28 cm

1/20



PIKOWNIK

Dibber • Посадочный конус • Pflanzholz • Plantator

NUMER
KATALOGOWY

100 575



18 cm



1/25



RĘKAWICE Z PAZURKAMI

Garden gloves with claws • Перчатки садовые с когтями
• Gartenhandschuhe mit Klauen

NUMER
KATALOGOWY

100 620



5/200



ZESTAW 3 NARZĘDZI OGRODNICZYCH

Set of 3 Tools • Набор из 3 инструментов • Satz von 3 Werkzeugen

NUMER
KATALOGOWY

100 590



1/7



AUTOMATYCZNY WIESZAK NA 9 NARZĘDZI

Hanger 9 tools • Вешалка 9 инструментов • Gerätehalter für 9 Geräte

NUMER
KATALOGOWY

100 596



1/15





SIEWNIK RĘCZNY

Handheld rotary spreader • Разбрасыватель-сеялка • Handspreizer

NUMER
KATALOGOWY

100 625



1/6



KOSZYK NA OWOCE

Fruit basket • Корзина на фрукты • Obstkorb

NUMER
KATALOGOWY

100 582



1/18



SZPILKA DO AGROWŁÓKNINY

Fixing anchors • Булавка для агроволокна • Nadel zum Gartenvlies

NUMER
KATALOGOWY

100 585

50 szt.



12,5 cm



50

100 586

50 szt.

20 cm

50

100 587

100 szt.

12,5 cm

100

KLIK



CLICK



GRABIE DO LIŚCI - POMARAŃCZOWE

Plastic leaf rake • Грабли размер M • Laubharke • Grebla plastic M

NUMER
KATALOGOWY

100 560

M



45 cm



1/70

KLIK



CLICK



GRABIE DO LIŚCI - POMARAŃCZOWE

Plastic leaf rake • Грабли размер L • Laubharke • Grebla plastic L

NUMER
KATALOGOWY

100 561

L



50 cm



1/50



GRABIE DO LIŚCI - POMARAŃCZOWE

Plastic leaf rake • Грабли размер XL • Laubharke • Grebla plastic XL

NUMER KATALOGOWY		↔	
100 562	XL	59 cm	1/20



KIJ ALUMINIOWY Z MOCOWANIEM KLIK

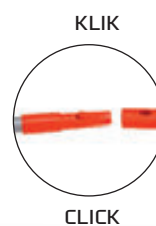

Aluminum pole with CliK connector • Щетка для газонокосилки
• Alustiel • Coada pentru grebla plastic

NUMER KATALOGOWY		↔	
100 563	24 mm	140 cm	1/10



GRABIE HARTOWANE



Steel rake • Грабли • Rechen aus Metall • Grebla cu coada metalica

NUMER KATALOGOWY		
040 508	14	1/5
040 509	16	1/5



GRABIE NIEOPRAWNE

Garden rake replacement head • Грабли • Rechen aus Metall • Grebla fara coada

NUMER KATALOGOWY		
040 501	14	1/10
040 502	16	1/10



KIJ DO GRABI

Pole for rake • Черенок для граблей • Rechenstiel • Coada pentru grebla

NUMER KATALOGOWY	↔	
040 513	140 cm	1/25





GRABIE DO LIŚCI REGULOWANE

Adjustable garden leaf rake • Грабли веерные регулируемые • Laubbesen
• Grebla pentru frunze

NUMER
KATALOGOWY



040 506

50 cm

118 cm

1/5



NOŻYCE DO TRAWY OBRACANE

Swivel Grass Shear • Ножницы для травы поворотные
• Rasenschere drehbar • Foarfeca gazon, rotativa

NUMER
KATALOGOWY



100 573

33 cm

1/48



PIŁA UNIWERSALNA SKŁADANA

Folding Saw • Пила универсальная складная • Klappsäge
• Fierastrau pentru gradina, pliabil

NUMER
KATALOGOWY



100 576

18 cm

1/12



SEKATOR DO ŻYWOPŁOTU TELESKOPOWY

Telescopic hedge shears • Ножницы для резки живой изгороди
• Teleskop Hand Heckenschere • Foarfeca telescopica pentru gard viu

NUMER
KATALOGOWY



100 577

65 - 85 cm

1/12



SEKATOR KOWADEŁKOWY

Anvil Pruning Shear • Секатор с наковаленкой • Gartenschere Amboss
• Foarfeca de gradina, cu nicovala

NUMER
KATALOGOWY



100 597

20,5 cm

1/10/60



SEKATOR KOWADEŁKOWY TELESKOPOWY

Anvil Lopper • Секатор с наковаленкой двуручный • Teleskop Amboss Astschere • Foarfeca de gradina cu maner telescopic, tip nicovală

NUMER
KATALOGOWY



100 578

62 - 93 cm

1/12



SEKATOR NOŻYCOWY

Bypass Pruning Shear • Секатор резчик • Baumschere Schere • Foarfeca de gradina

NUMER
KATALOGOWY



100 579

21,5 cm

1/10/60



SEKATOR NOŻYCOWY TELESKOPOWY

Bypass Lopper • Секатор резчик двуручный • Teleskop Astschere • Foarfeca de gradina cu maner telescopic

NUMER
KATALOGOWY



100 580

62 - 93 cm

1/12



WIDŁY GOSPODARCZE

Manure fork • Четырехзубые вилы • Dunggabel • Furca pentru gunoi

NUMER
KATALOGOWY



040 540

21 cm

4

1/5



WIDŁY OGRODOWE HARTOWANE

Garden fork • Трехзубые вилы • Spatengabel • Furca pentru sapat

NUMER
KATALOGOWY



040 541

21 cm

4

1/5





SZUFELKA C.O.

Coal shovel • Сокор металлический • Kohleschaufel • Lopata carbuni

NUMER
KATALOGOWY

050 198



1



motive
Jakość ma znaczenie



SZPADEL HARTOWANY

Tempered spade • Лопата штыковая каленая • Spaten aus gehärteten Stahl mit Metallstiel • Cazma cu maner metal

NUMER
KATALOGOWY

040 504



20 cm



115 cm



1/5



SZPADEL WZMOCNIONY OPRAWNY

Spade, wooden handle • Лопата штыковая укрепленная • Spaten • Cazma cu maner lemn

NUMER
KATALOGOWY

040 510



20 cm



125 cm



1/5



ŁOPATA HARTOWANA

Tempered shovel • Лопата каленая • Schaufel aus gehärteten Stahl mit Metallstiel • Lopata otel

NUMER
KATALOGOWY

040 503



24 cm



120 cm



1/5



ŁOPATA PIASKOWA OPRAWNA

Shovel, wooden handle • Лопата совковая • Sandschaufel • Lopata cu maner lemn

NUMER
KATALOGOWY

040 500



24 cm



120 cm



1/5



ŁOPATA WĘGLOWA 2 HARTOWANA

Square shovel • Лопата совковая кованая • Randschaufel
• Lopata otel, dreptunghiulara

NUMER KATALOGOWY			
040 516	24 cm	120 cm	1/5

ŁOPATA WĘGLOWA 3 OPRAWNA

Wood handle square shovel • Лопата совковая с деревянным черенком
• Randschaufel mit Holzstiel • Lopata dreptunghiulara, cu maner lemn

NUMER KATALOGOWY			
040 515	25 cm	120 cm	1/5

TRZON DO SZPADLI

Wooden handle • Черенок для штыковой лопаты • Spatenstiel
• Coada pentru cazma

NUMER KATALOGOWY		
040 511	90 cm	1/10

TRZON DO ŁOPAT

Wooden handle • Черенок для лопаты • Schaufelstiel • Coada pentru lopata

NUMER KATALOGOWY		
040 512	100 cm	1/10

SZCZOTKA DO KOSIARKI ZE SKROBAKIEM

Lawnmower brush • Чистящая щетка • Rasenmäherbürste mit Schaber
• Perie pentru mașină de tuns iarba

NUMER KATALOGOWY	
050 650	1/50

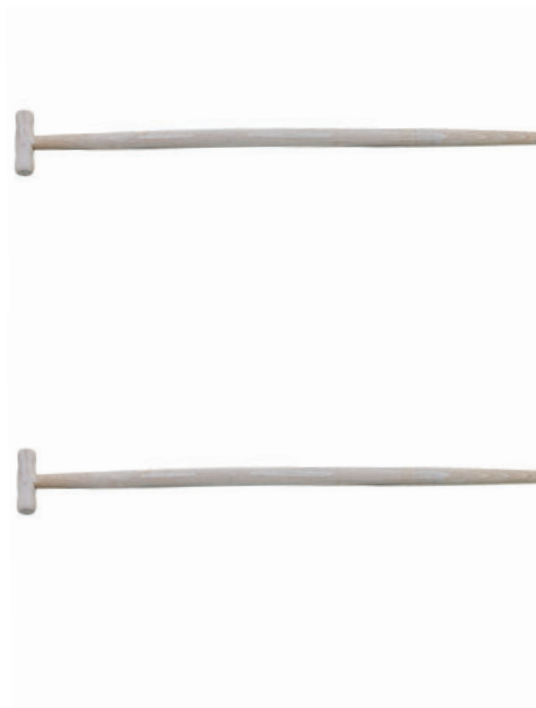



motive
Jakość ma znaczenie



SIEKIERA ROZŁUPUJĄCA

Splitting axe • Топор – колун • Spaltaxt • Topor pentru despicat

NUMER KATALOGOWY	kg	
040 407	1 kg	1/3/12
040 408	2 kg	1/3/6



motive
Jakość ma znaczenie



SIEKIERA

Tempered axe • Каленый топор • Axt mit Glasfaserstiel • Topor

NUMER KATALOGOWY	kg	
040 401	0.6 kg	1/3/6/24
040 402	0.8 kg	1/3/24
040 403	1.0 kg	1/3/12
040 404	1.25 kg	1/3/12
040 405	1.6 kg	1/3/6
040 406	2.0 kg	1/3/6



SIEKIERA HARTOWANA

Tempered axe, wooden handle • Каленый топор • Axt mit gehärtet Kopf • Topor, lama otel + coada lemn

NUMER KATALOGOWY	kg	
040 410	0.7 kg	1/3
040 411	0.9 kg	1/3
040 412	1.5 kg	1/3



TRZON DO SIEKIERY

Shaft to hatchet • Черенок для топора • Axtstiel • Coada pentru topor

NUMER KATALOGOWY		
040 459	50 cm	1/25
040 460	60 cm	1/25
040 461	70 cm	1/25
040 462	80 cm	1/25
040 463	90 cm	1/25



TRZON DO TOPORKA

Shaft to hatchet • Черенок для топора • Axtstiel • Coada pentru topor

NUMER KATALOGOWY		
040 470	36 cm	1/25



ZESTAW SKLEPOWY

Shopping connector BOX • Набор фитингов - BOX • Verbindungsstück Satz
• Conectori- set box

NUMER
KATALOGOWY



R 1500

1



PROFESJONALNA PREZENTACJA PRODUKTÓW W TWOIM SKLEPIE LUB SKŁADZIE

ZAINTERESOWANY?

Skontaktuj się z naszym przedstawicielem w Twoim regionie

Stwórz własną ekspozycję korzystając z gotowych regałów modułowych

- ✓ w ofercie dostępne są moduły w kilku rozmiarach
- ✓ zatowarowane według naszych sugestii lub wyboru Klienta
- ✓ dostępne w wersji podstawowej lub premium (podświetlane)

SZEROKOŚĆ	GŁĘBOKOŚĆ	WYSOKOŚĆ
60 cm	60 cm	210 cm + logo
125 cm	60 cm	210 cm + logo
133 cm	60 cm	210 cm + logo

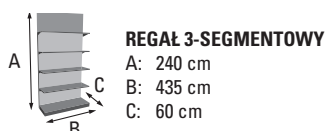
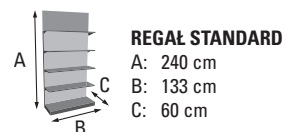



REGAŁ WYSOKI MASCOT
 A: 277 cm
 B: 119 cm
 C: 56 cm



REGAŁ - WYSPA MASCOT
 A: 152 cm
 B: 140 cm
 C: 60 cm



REGAŁ - PRZEBIERALNIA MASCOT
 A: 277 cm
 B: 119 cm
 C: 119 cm



REGAŁ ZE SZPACHLAMI
 A: 240 cm
 B: 60 cm
 C: 60 cm



REGAŁ Z TAŚMAMI
 A: 240 cm
 B: 133 cm
 C: 60 cm



REGAŁ GLAZURNICZY
 A: 240 cm
 B: 133 cm
 C: 60 cm



REGAŁ 4-SEGMENTOWY
 A: 240 cm
 B: 435 cm
 C: 60 cm



REGAŁ Z WIERTŁAMI
 A: 240 cm
 B: 133 cm
 C: 60 cm



REGAŁ 2-SEGMENTOWY
 A: 240 cm
 B: 266 cm
 C: 60 cm



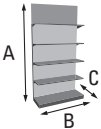

REGAŁ 4-SEGMENTOWY
 A: 240 cm
 B: 459 cm
 C: 60 cm

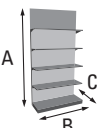

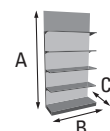

REGAŁ 3-SEGMENTOWY
 A: 240 cm
 B: 399 cm
 C: 60 cm



**REGAŁ OGRODOWY
5-SEGMENTOWY**
 A: 240 cm
 B: 665 cm
 C: 60 cm

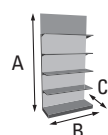

**REGAŁ OGRODOWY
2-SEGMENTOWY**
 A: 240 cm
 B: 266 cm
 C: 60 cm



REGAŁ OGRODOWY
3-SEGMENTOWY
A: 210 cm
B: 180 cm
C: 60 cm



REGAŁ OGRODOWY
3-SEGMENTOWY
A: 240 cm
B: 399 cm
C: 60 cm

REGAŁY NA ODKŁADY

Sposób na profesjonalną prezentację produktów oraz efektywne wykorzystanie przestrzeni

- ✓ wykorzystując specjalne ramy zabudowujące nasze regały uzyskujesz dodatkowe miejsce na górze do przechowywania nadmiaru towaru, bez konieczności składowania go na swoim zapleczu
- ✓ z kolei łatwy i szybki dostęp do towaru w odkładzie minimalizuje pojawienie się braków na wieszakach, czy półkach regału
- ✓ estetyczne i reklamowe drzwi zamykające odkład zwracają uwagę klienta oraz oznakowują grupę asortymentu na regale
- ✓ dostosowanie wysokości ramy i odkładu nad regałem pozwala w pełni wykorzystać dostępną przestrzeń w każdym sklepie, czy składzie
- ✓ łączenie ze sobą ram umożliwia tworzenie alejek regałowych

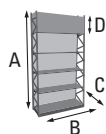

REGAŁ Z ODKŁADEM

- A: 300-350 cm
- B: 258,5 cm
- C: 71,5 cm
- D: max 120 cm



STOJAK Z USZCZELKAMI
 A: 210 cm
 B: 77 cm
 C: 60 cm



REGAŁ Z MIESZADŁAMI
 A: 240 cm
 B: 63 cm
 C: 60 cm



STOJAK Z WIERTŁAMI



EKSPOZYTOR NABŁATOWY
 A: 60 cm
 B: 30 cm
 C: 30 cm



STOJAK NA POZIOMICE
 A: 83 cm
 B: 27,5 cm
 C: 41 cm



STOJAK Z PAPIERAMI ŚCIERNYMI



REGAŁ Z WAŁKAMI
 A: 240 cm
 B: 63 cm
 C: 60 cm



REGAŁ Z TAŚMAMI
 A: 210 cm
 B: 70 cm
 C: 60 cm



STOJAK NA TAŚMY
 A: 80 cm
 B: 120 cm
 C: 80 cm



KOSZ NA TAŚMY
 A: 80 cm
 B: 120 cm
 C: 80 cm



EKSPOZYTOR NA TAŚMY
 A: 57 cm
 B: 16 cm
 C: 35 cm

PRZEJDŹ NA WYŻSZY POZIOM KORZYŚCI ZAMAWIAJ ONLINE!

ZAŁÓŻ I AKTYWUJ KONTO U HANDLOWCA Z TWOJEGO REGIONU,
ZAMAWIAJ W PROSTY SPOSÓB, BEZPOŚREDNIO ZE STRONY:

www.interb2b.abstore.pl

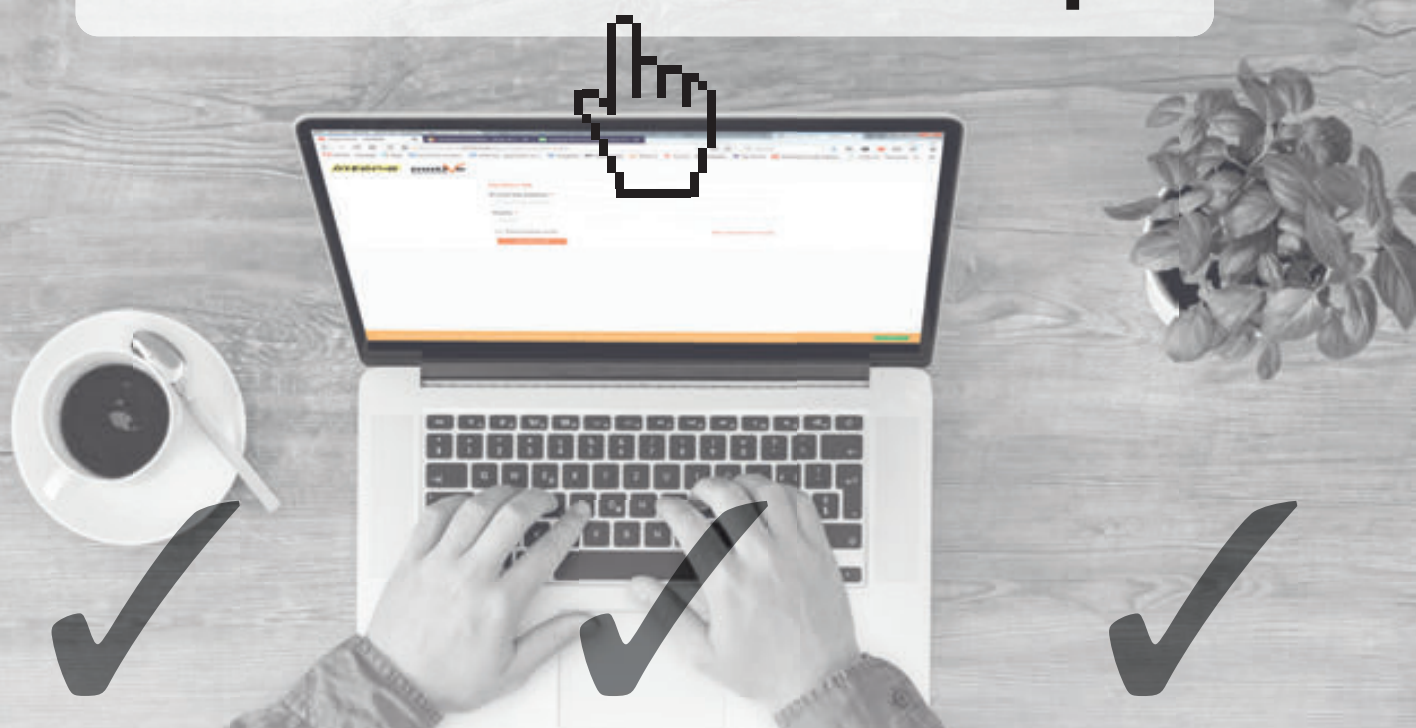

Intuicyjne przeglądanie asortymentu, w tym również nowości produktowych

Łatwe konfigurowanie nowych zamówień oraz powielanie poprzednich, bez konieczności ponownego wpisywania pozycji

Wygodny dostęp do historii swoich zamówień i rozrachunków

OPTYMALIZUJ SWÓJ CENNY CZAS, **ZAMAWIAJ KIEDY I GDZIE CHCESZ**

O SZCZEGÓŁY ZAPYTAJ HANDLOWCĄ W TWOIM REGIONIE

**SZUKASZ OKAZJI,
CHCESZ ZAOSZCZĘDZIĆ?**

ODWIEDŹ
NASZ % OUTLET



www.inter-s.pl/outlet

Wydanie: marzec 2022

motive
Jakość ma znaczenie



@narzedzia.motive



Inter-s, ul. Mazowiecka 10, 96-300 Żyrardów, tel.: +48 46 854 42 47, fax: 46 855 00 76, e-mail: biuro@inter-s.pl, www.inter-s.pl, www.motive.tools